

















**META Mitigeur monocommande de lavabo sans garniture d'écoulement -  
Chrome brossé**

META

33 525 660



- saillie 105 mm
- bec déverseur fixe
- jet circulaire enrichi en air
- hauteur de robinetterie 138 mm
- hauteur jusqu'au mousseur 57 mm
- diamètre de percement 35 mm
- rosace Ø 50 mm en option
- 2x flexible de pression M 8 x 1 vissé, étanchéité contrôlée
- débit maxi. 5,7 l/min
- sans plomb
- Ce produit contribue au respect des exigences des systèmes d'évaluation des bâtiments écologiques, par exemple LEED®, BREEAM®, DGNB

	Chrome brossé	33 525 660-93
	Chrome	33 525 660-00
	Platine brossé	33 525 660-06
	Platine	33 525 660-08
	Dark Chrome	33 525 660-19
	Or clair	33 525 660-26
	Or clair brossé	33 525 660-27
	Laiton brossé (Or 23cts)	33 525 660-28
	Rouge	33 525 660-29
	Orange	33 525 660-30
	Vert foncé	33 525 660-31
	Noir mat	33 525 660-33
	Bronze brossé	33 525 660-42
	Champagne brossé (Or 22cts)	33 525 660-46
	Champagne (Or 22cts)	33 525 660-47
	Dark Platinum brossé	33 525 660-99

**META Mitigeur monocommande de lavabo sans garniture d'écoulement -  
Chrome brossé**

META

33 525 660  
mm [inches]

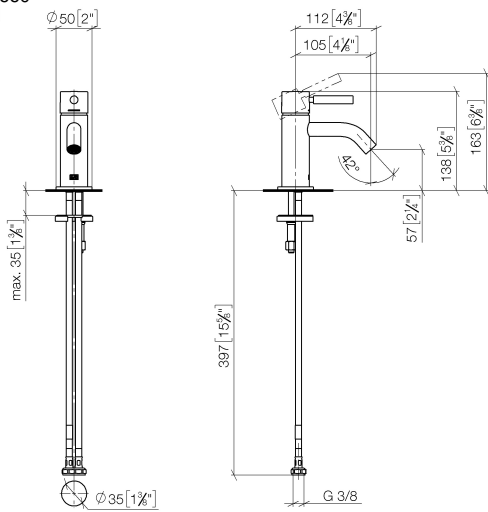

**Diagramme de débit**



**Certificats**

LGA\_29690.

DVGW\_DW-  
6506DN0128.

WRAS\_2003058.

**META Mitigeur monocommande de lavabo sans garniture d'écoulement -  
Chrome brossé**

META

33 525 660

Les pièces pour les  
autres finitions  
peuvent être  
trouvées ici : Chrome

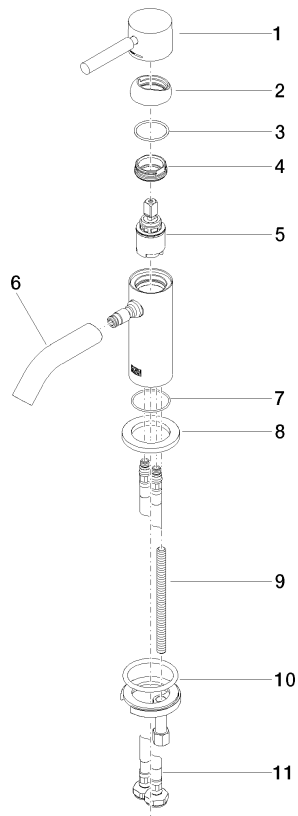

**Liste des pièces de rechange**

N°	Article Numéro	Désignation	Fréquence de montage	Délai de livraison
1	90 20 66 009 00-93	poignée	1	20
2	09 28 30 043-93	hotte	1	20
3	09 14 10 120 90	joint	1	2
4	09 24 04 266 90	écrou	1	2
5	90 15 05 044 00 90	cartouche	1	2
6	90 11 06 212 00-93	bec déverseur	1	20
7	09 14 10 202 90	joint	1	2
8	09 27 66 006-93	rosace	1	20
9	09 31 11 012 90	tige	1	2
10	04 30 11 038 00 90	set de fixation	1	2
11	04 30 04 100 00 90	flexible	2	2