

33 816 809



- saillie 241 mm
- bec pivotant 360°
- jet enrichi en air
- débit d'eau maxi. 7 l/min avec une pression d'écoulement de 3 bars
- sans plomb
- Ce produit contribue au respect des exigences des systèmes d'évaluation des bâtiments écologiques, par exemple LEED®, BREEAM®, DGNB

	Laiton brossé (Or 23cts)	33 816 809-28
	Chrome	33 816 809-00
	Platine brossé	33 816 809-06
	Platine	33 816 809-08
	Laiton (Or 23cts)	33 816 809-09
	Dark Chrome	33 816 809-19
	Noir mat	33 816 809-33
	Champagne brossé (Or 22cts)	33 816 809-46
	Champagne (Or 22cts)	33 816 809-47
	Chrome brossé	33 816 809-93
	Dark Platinum brossé	33 816 809-99

Accessoires recommandés

VAIA Distributeur avec rosace - Laiton brossé (Or 23cts) 82 434 809-28



33 816 809



Diagramme de débit



Certificats

LGA_29299.

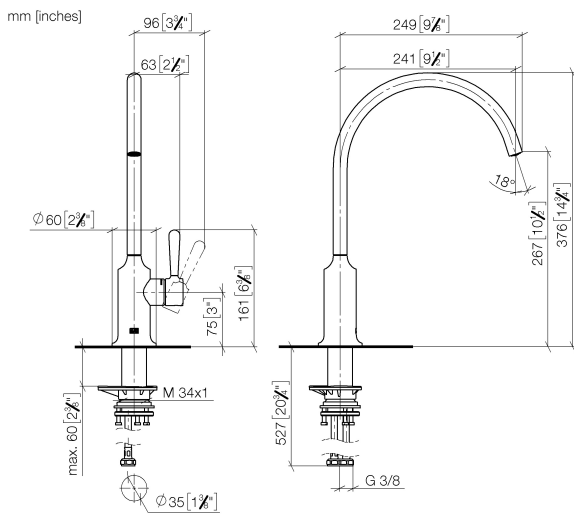
33 816 809

Les pièces pour les autres finitions peuvent être trouvées ici : Chrome

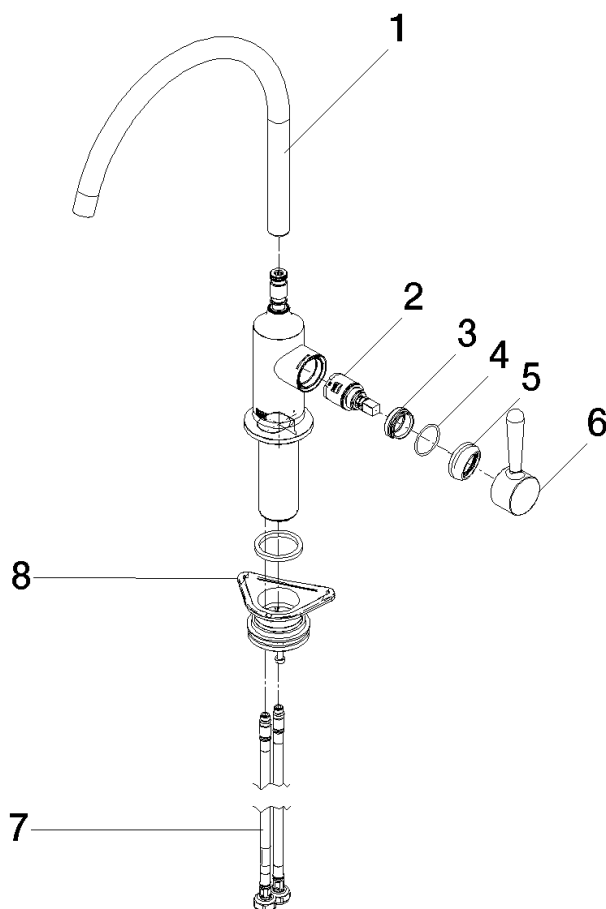

Liste des pièces de rechange

N°	Article Numéro	Désignation	Fréquence de montage	Délai de livraison
1	90 28 22 396 00-28	bec déverseur	1	-
La pièce de rechange ne peut plus être commandée, veuillez commander l'article de remplacement				
2	90 15 05 042 00 90	cartouche	1	2
3	09 24 04 266 90	écrou	1	2
4	09 14 10 091 90	joint	1	2
5	90 28 30 052 00-28	hotte	1	20
6	90 20 80 050 00-28	poignée	1	-
La pièce de rechange ne peut plus être commandée, veuillez commander l'article de remplacement				
7	04 30 04 100 00 90	flexible	2	2
8	04 23 10 044 08 90	set de fixation	1	2