

Inverseur à 3 voies à encastrer - Platine brossé

CL.1

36 210 740



- inverseur rotatif
- sans rosace
- poignée Ø 60 mm

S'adapte aux gammes suivantes : CL.1,
META, CYO

	Platine brossé	36 210 740-06
	Chrome	36 210 740-00
	Or clair	36 210 740-26
	Or clair brossé	36 210 740-27
	Laiton brossé (Or 23cts)	36 210 740-28
	Noir mat	36 210 740-33
	Bronze brossé	36 210 740-42
	Champagne brossé (Or 22cts)	36 210 740-46
	Champagne (Or 22cts)	36 210 740-47
	Dark Platinum brossé	36 210 740-99

Accessoires requis



- Inverseur à 3 voies à encastrer -** 35 203 970 90
- profondeur de montage max. 160 mm
 - profondeur de montage mini. 85 mm

36 210 740

mm [inches]



Diagramme de débit



Certificats

LGA_38380.

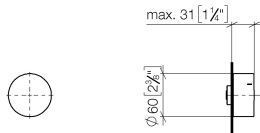
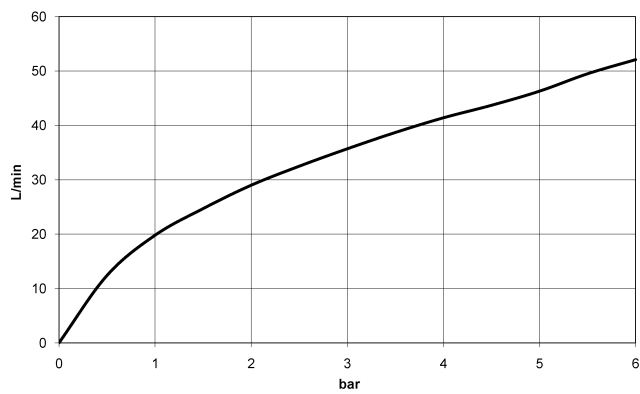
WRAS_2307045.

36 210 740

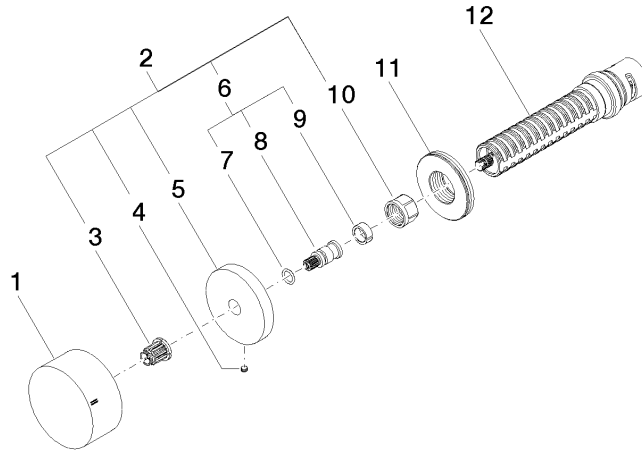

Liste des pièces de rechange

N°	Article Numéro	Désignation	Fréquence de montage	Délai de livraison
1	09 20 74 045-06	poignée	1	60
2	04 27 74 004 00-06	rosace	1	10
3	90 12 12 002 00 90	douille d'enclenchement	1	2
4	09 31 11 055 90	tige	1	2
5	09 27 74 004-06	rosace	1	10
6	04 29 06 020 00-00	tige	1	10
7	90 14 10 060 00 90	joint	1	2
8	09 29 06 020-06	tige	1	-
La pièce de rechange ne peut plus être commandée, veuillez commander l'article de remplacement				
9	90 14 15 020 03 90	anneau	1	2
10	90 23 30 023 00 90	écrou	1	2
11	09 30 01 107 90	douille	1	2
12	90 90 03 303 10 90	inverseur	1	2