







36 607 707



- rosace 60 x 60 mm
- avec marquage chaud
- tête de commande avec broche et douille à sectionner

	Platine brossé	36 607 707-06
	Chrome	36 607 707-00
	Dark Chrome	36 607 707-19
	Champagne brossé (Or 22cts)	36 607 707-46
	Champagne (Or 22cts)	36 607 707-47
	Dark Platinum brossé	36 607 707-99

Accessoires requis



- Robinet à encastrer 1/2" -** 35 607 970 90
- profondeur de montage max. 150 mm
 - profondeur de montage mini. 105 mm

36 607 707

mm [inches]

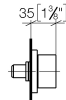
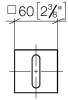

Certificats

DVGW_DW-
6501DN0116.

IAPMO_4976 (1).

LGA_29931.

WRAS_2010066.

LGA_29932.

36 607 707

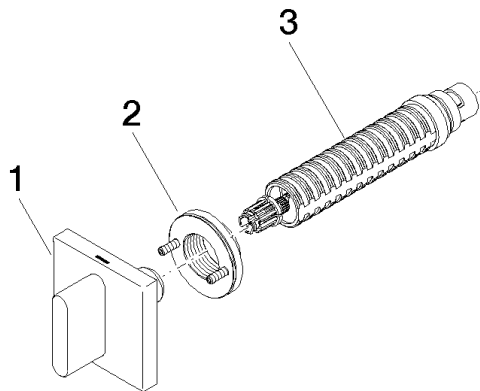

Liste des pièces de rechange

N°	Article Numéro	Désignation	Fréquence de montage	Délai de livraison
1	90 20 70 051 03-06	poignée (hot)	1	10
2	90 21 02 108 00 90	rondelle	1	2
3	90 90 03 142 00 90	tête céramique	1	2