

Robinet d'arrêt à encastrer fermant à gauche chaud 1/2" - Chrome







CL.1

36 607 717



- rosace 60 x 60 mm
- avec marquage chaud
- tête de commande avec broche et douille à sectionner

S'adapte aux gammes suivantes : CL.1, CYO

	Chrome	36 607 717-00
	Platine brossé	36 607 717-06
	Laiton brossé (Or 23cts)	36 607 717-28
	Champagne brossé (Or 22cts)	36 607 717-46
	Champagne (Or 22cts)	36 607 717-47
	Dark Platinum brossé	36 607 717-99

Accessoires requis



- Robinet à encastrer 1/2" -** 35 607 970 90
- profondeur de montage max. 150 mm
 - profondeur de montage mini. 105 mm

36 607 717

mm [inches]

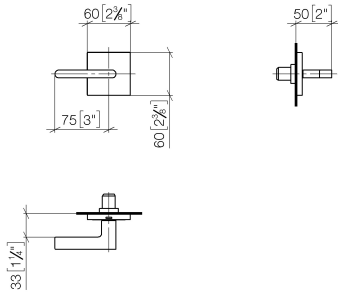

Certificats

DVGW_DW-
6501DN0116.

IAPMO_4976 (1).

LGA_29931.

WRAS_2010066.

LGA_29932.

36 607 717

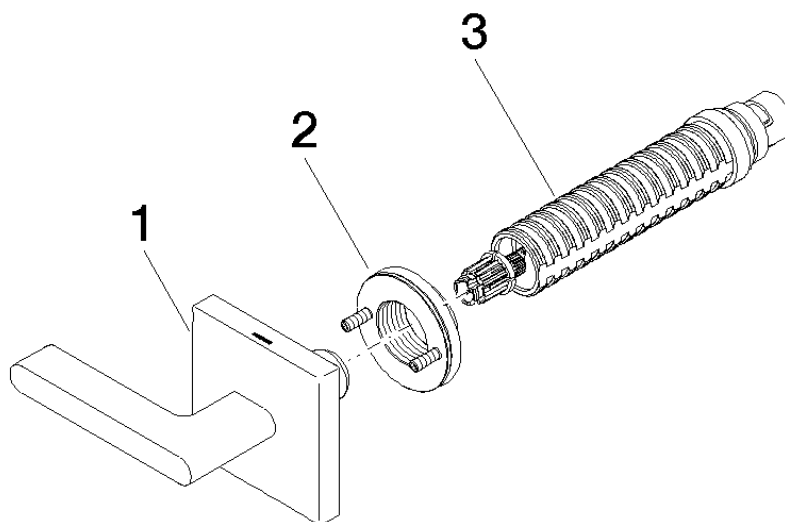

Liste des pièces de rechange

N°	Article Numéro	Désignation	Fréquence de montage	Délai de livraison
1	90 20 70 057 05-00	poignée (hot)	1	10
2	90 21 02 108 00 90	rondelle	1	2
3	90 90 03 142 00 90	tête céramique	1	2