







ST 010 107 7370



- saillie 135 mm
- bec déverseur fixe
- jet circulaire enrichi en air
- hauteur de robinetterie 72 mm
- hauteur jusqu'au mousseur 40 mm
- diamètre de percement des robinets latéraux 32 mm
- diamètre de percement du bec 35 mm
- sans rosace
- 2x flexible de pression 1/2" x 1/2"
- débit maxi. 7 l/min
- sans plomb
- Ce produit contribue au respect des exigences des systèmes d'évaluation des bâtiments écologiques, par exemple LEED®, BREEAM®, DGNB

	Platine	ST 010 107 7370-08
	Chrome	ST 010 107 7370-00
	Platine brossé	ST 010 107 7370-06
	Laiton (Or 23cts)	ST 010 107 7370-09
	Laiton brossé (Or 23cts)	ST 010 107 7370-28
	Dark Platinum brossé	ST 010 107 7370-99

Composants individuels de ce set

Ce set requiert les composants suivants

1x 20 700 370-08



2x 11 170 370-08









ST 010 107 7370



- saillie 135 mm
- bec déverseur fixe
- jet circulaire enrichi en air
- hauteur de robinetterie 72 mm
- hauteur jusqu'au mousseur 40 mm
- diamètre de percement des robinets latéraux 32 mm
- diamètre de percement du bec 35 mm
- sans rosace
- 2x flexible de pression 1/2" x 1/2"
- débit maxi. 7 l/min
- sans plomb
- Ce produit contribue au respect des exigences des systèmes d'évaluation des bâtiments écologiques, par exemple LEED®, BREEAM®, DGNB

Convient uniquement à un lavabo avec trop-plein.

	Platine	20 700 370-08
	Chrome	20 700 370-00
	Platine brossé	20 700 370-06
	Laiton (Or 23cts)	20 700 370-09
	Laiton brossé (Or 23cts)	20 700 370-28
	Dark Platinum brossé	20 700 370-99

ST 010 107 7370

Les pièces pour les autres finitions peuvent être trouvées ici : [Chrome](#)

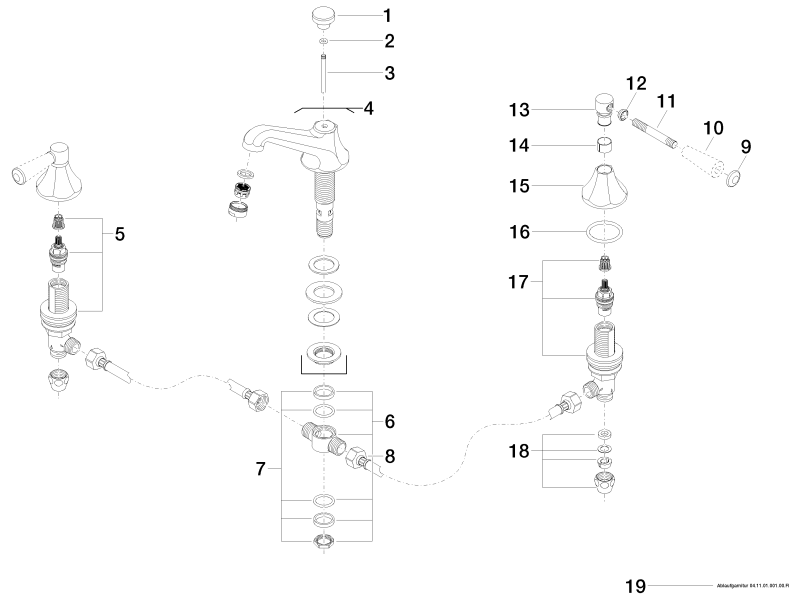

Liste des pièces de rechange









N°	Article Numéro	Désignation	Fréquence de montage	Délai de livraison
1	09 20 36 030-08	poignée	1	40
2	90 14 10 062 00 90	joint	1	2
3	09 31 09 004-08	tige	1	40
4	13 700 380-08	bec déverseur	1	40
5	90 17 11 040 51 90	partie latérale	1	2
6	90 17 11 020 10 90	raccord multiple	1	2
7	90 23 10 012 00 90	kit de garniture	1	2
8	04 30 04 096 00 90	flexible	2	2
9	09 30 30 062-08	vis	2	40
10	11 170 370-08	MADISON Grand insert à poignée - Platine	2	40
11	09 28 22 013 90	tuyau	2	2
12	09 20 37 001-08	poignée	2	40
13	09 20 82 000-08	poignée	2	40
14	90 18 40 041 00 90	douille	2	2
15	09 27 37 014-08	rosace	2	40
16	90 14 10 043 00 90	joint	2	2
17	90 17 11 040 50 90	partie latérale	1	2
18	90 23 30 040 00-08	joint américain	2	40
19	90 11 01 001 00-08	garniture d'écoulement	1	40

ST 010 107 7370

- pour robinetteries de lavabo

ATTENTION :Les inserts à poignée doivent être commandés en supplément de la robinetterie !



	Platine	11 170 370-08
	Chrome	11 170 370-00
	Or (23,9cts)	11 170 370-01
	Platine brossé	11 170 370-06
	Laiton (Or 23cts)	11 170 370-09
	blanc	11 170 370-12
	noir	11 170 370-13
	Laiton brossé (Or 23cts)	11 170 370-28
	Dark Platinum brossé	11 170 370-99

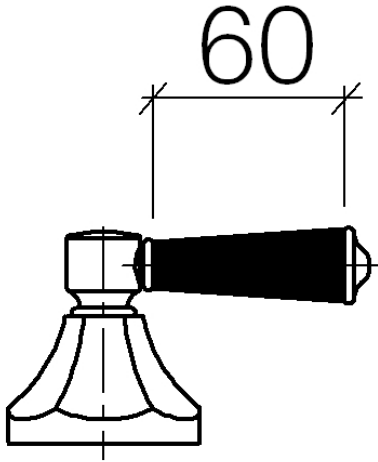

ST 010 107 7370

Les pièces pour les
autres finitions
peuvent être
trouvées ici : Chrome



