







ST 060 113 2985



- plaque de recouvrement 120 x 120 mm
- rosace 60 x 60 mm
- poignée de graduation avec bouton de sécurité à 38°C
- cartouche de thermostat
- 2x tête de commande avec broche et douille à sectionner

	Platine	ST 060 113 2985-08
	Chrome	ST 060 113 2985-00
	Platine brossé	ST 060 113 2985-06
	Or clair brossé	ST 060 113 2985-27
	Laiton brossé (Or 23cts)	ST 060 113 2985-28
	Chrome brossé	ST 060 113 2985-93
	Dark Platinum brossé	ST 060 113 2985-99

Composants individuels de ce set

Ce set requiert les composants suivants

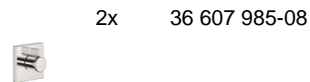
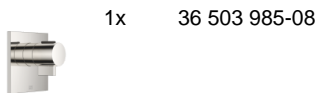

ST 060 113 2985



- plaque de recouvrement 120 x 120 mm
- poignée de graduation avec bouton de sécurité à 38°C
- cartouche de thermostat

S'adapte aux gammes suivantes : IMO, MEM, CL.1, CYO

	Platine	36 503 985-08
	Chrome	36 503 985-00
	Platine brossé	36 503 985-06
	Dark Chrome	36 503 985-19
	Or clair brossé	36 503 985-27
	Laiton brossé (Or 23cts)	36 503 985-28
	Noir mat	36 503 985-33
	Champagne brossé (Or 22cts)	36 503 985-46
	Champagne (Or 22cts)	36 503 985-47
	Chrome brossé	36 503 985-93
	Dark Platinum brossé	36 503 985-99

Accessoires requis



- xTOOL Module de thermostat à encastrer sans réglage du débit -** 35 503 970 90
- profondeur de montage max. 160 mm
 - profondeur de montage mini. 95 mm

ST 060 113 2985

mm [inches]



Diagramme de débit



Certificats

WRAS_2011026.

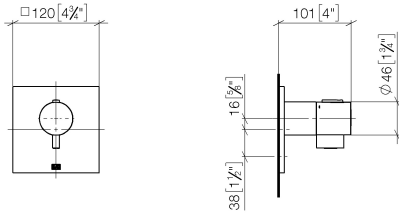
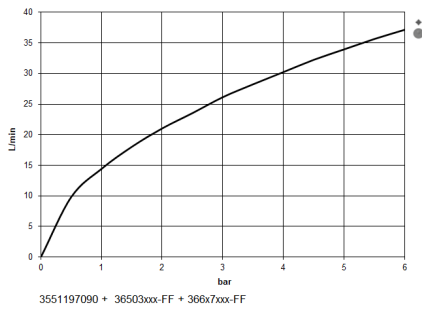
DVGW_DW-
6512DN0706.

LGA_29930.

LGA_29932.

ST 060 113 2985

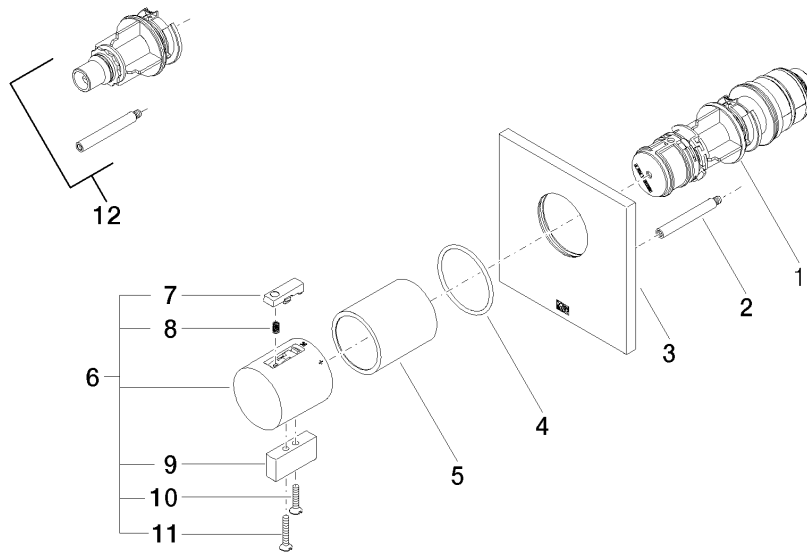





Liste des pièces de rechange

N°	Article Numéro	Désignation	Fréquence de montage	Délai de livraison
1	90 15 02 063 00 90	cartouche	1	2
2	90 31 09 095 00 90	barre	1	2
3	09 11 02 196-08	recouvrement	1	60
4	90 14 10 049 00 90	joint	1	2
5	90 21 02 112 00-08	douille	1	40
6	04 17 33 006 00-08	poignée	1	60
7	90 21 33 011 00-13	poignée	1	2
8	90 16 02 027 00 90	ressort	1	2
9	09 20 33 006-08	poignée	1	40
10	09 30 30 159-08	vis	1	40
11	09 30 30 160-08	vis	1	40
12	12 178 970 90	Rallonge 46 mm -	1	2

ST 060 113 2985



- rosace 60 x 60 mm
- tête de commande avec broche et douille à sectionner

	Platine	36 607 985-08
	Chrome	36 607 985-00
	Platine brossé	36 607 985-06
	Dark Chrome	36 607 985-19
	Or clair brossé	36 607 985-27
	Laiton brossé (Or 23cts)	36 607 985-28
	Chrome brossé	36 607 985-93
	Dark Platinum brossé	36 607 985-99

Accessoires requis



- Robinet à encastrer 1/2" -** 35 607 970 90
- profondeur de montage max. 145 mm
 - profondeur de montage mini. 75 mm

ST 060 113 2985

mm [inches]

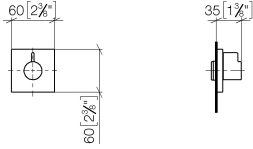

Certificats

DVGW_DW-
6501DN0116.

WRAS_2011026.

IAPMO_4976 (2).

LGA_29931.

WRAS_2010066.

DVGW_DW-
6512DN0706.

LGA_29932.

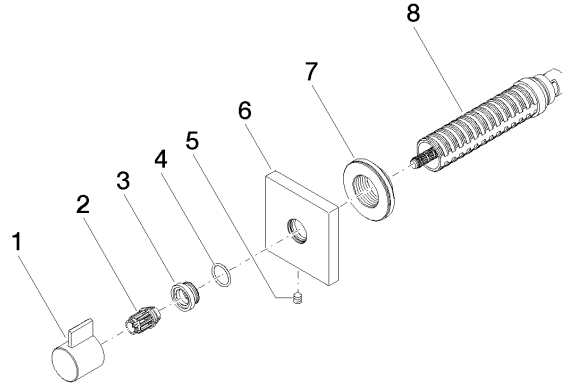

Liste des pièces de rechange

N°	Article Numéro	Désignation	Fréquence de montage	Délai de livraison
1	09 20 98 002-08	poignée	1	40
2	09 12 12 005 90	douille d'enclenchement	1	2
3	09 12 12 043-08	prise	1	40
4	09 14 10 017 90	joint	1	2
5	90 31 11 004 00 90	tige	1	2
6	09 27 98 014-08	rosace	1	40
7	09 21 02 151 90	douille	1	2
8	90 90 03 202 00 90	tête céramique	1	2