

17 861 680



- 145mm projection
 - rigid, thermally insulated spout
 - laminar flow
 - height of mixer 233 mm
 - height up to laminar flow regulator 213 mm
 - hole diameter 35 mm
 - provides filtered, hot water up to 93°C
 - provides filtered, cold water
 - max. flow 2 l/min at 3 bar flow pressure
 - ready-to-use control unit for wall mounting (137mm x 159mm x 60mm)
 - electronic magnetic valve
 - 100-230 V, 50-60 Hz, 18 W power supply unit, incl. country-specific adapter set
 - lead-free
 - Spout ring cannot be removed.
 - This product can help a building meet the requirements of Green Building Rating Systems, e.g. LEED®, BREEAM®, DGNB
- A minimum flow pressure of 3 bar is necessary for the HOT & COLD WATER DISPENSER to work perfectly in conjunction with a hot water tank and filter.**
In addition, the installation must be above a kitchen sink.
The filter cartridge must be changed every six months. The installation instructions contain further information for guidance.
Detailed planning information and technical data can be found at www.dornbracht.com/professional

A minimum flow pressure of 3 bar is necessary for the HOT & COLD WATER DISPENSER to work perfectly in conjunction with a hot water tank and filter.

In addition, the installation must be above a kitchen sink.

The filter cartridge must be changed every six months. The installation instructions contain further information for guidance.

Detailed planning information and technical data can be found at www.dornbracht.com/professional

	Brushed Platinum	17 861 680-06
	Chrome	17 861 680-00
	Platinum	17 861 680-08
	Dark Chrome	17 861 680-19
	Brushed Durabronze (23kt Gold)	17 861 680-28
	Brushed Champagne (22kt Gold)	17 861 680-46
	Champagne (22kt Gold)	17 861 680-47
	Brushed Dark Platinum	17 861 680-99

Required miscellaneous



Hot water tank incl. filter - 12 893 970 90

17 861 680

mm [inches]

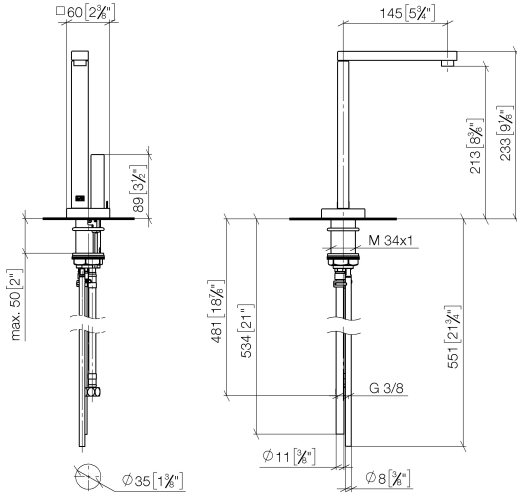

Flow rate chart

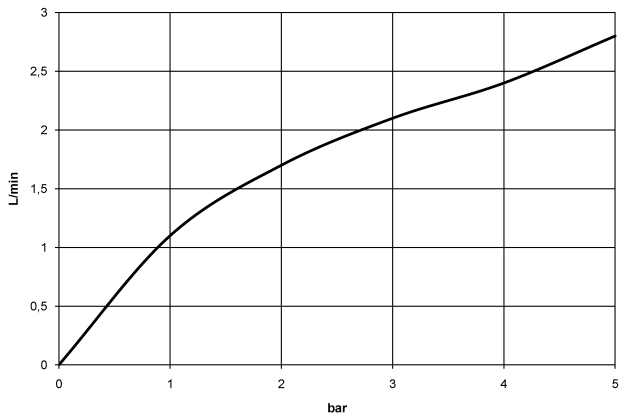

Codes & Standards

ASME A112.18.1

cUPC

DIN 4109

ISO 3822

NSF372

NSF61

Ü-Zeichen



LOT HOT & COLD WATER DISPENSER - Brushed Platinum

LOT

17 861 680

Certificates

IAPMO_4976

IAPMO_N-4

LGA_28

IAPMO_6

17 861 680

Product version from 4/1/2014 to 5/27/2021

Product version from 5/27/2021 to 5/28/2022

Product version from 5/28/2022

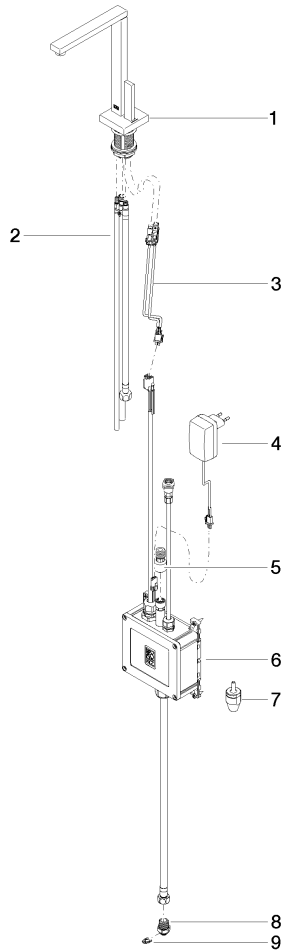



LOT HOT & COLD WATER DISPENSER - Brushed Platinum

LOT

17 861 680

Spare parts list

Product version from 4/1/2014 to 5/27/2021

Product version from 5/27/2021 to 5/28/2022

Product version from 5/28/2022

No.	Item Number	Name	Quantity used	Delivery time
	90 17 85 100 03-06	fitting	9	10