

17 861 680



- 145mm projection
- rigid, thermally insulated spout
- laminar flow
- height of mixer 233 mm
- height up to laminar flow regulator 213 mm
- hole diameter 35 mm
- provides filtered, hot water up to 93°C
- provides filtered, cold water
- max. flow 2 l/min at 3 bar flow pressure
- ready-to-use control unit for wall mounting (137mm x 159mm x 60mm)
- electronic magnetic valve
- 100-230 V, 50-60 Hz, 18 W power supply unit, incl. country-specific adapter set
- lead-free

• Spout ring cannot be removed.

• This product can help a building meet the requirements of Green Building Rating Systems, e.g. LEED®, BREEAM®, DGNB

A minimum flow pressure of 3 bar is necessary for the HOT & COLD WATER DISPENSER to work perfectly in conjunction with a hot water tank and filter.

In addition, the installation must be above a kitchen sink.

The filter cartridge must be changed every six months. The installation instructions contain further information for guidance.

Detailed planning information and technical data can be found at

www.dornbracht.com/professional

A minimum flow pressure of 3 bar is necessary for the HOT & COLD WATER DISPENSER to work perfectly in conjunction with a hot water tank and filter.

In addition, the installation must be above a kitchen sink.

The filter cartridge must be changed every six months. The installation instructions contain further information for guidance.

Detailed planning information and technical data can be found at www.dornbracht.com/professional

	Champagne (22kt Gold)	17 861 680-47
	Chrome	17 861 680-00
	Brushed Platinum	17 861 680-06
	Platinum	17 861 680-08
	Dark Chrome	17 861 680-19
	Brushed Durabross (23kt Gold)	17 861 680-28
	Brushed Champagne (22kt Gold)	17 861 680-46
	Brushed Dark Platinum	17 861 680-99

Required miscellaneous



Hot water tank incl. filter - 12 893 970 90

17 861 680

mm [inches]

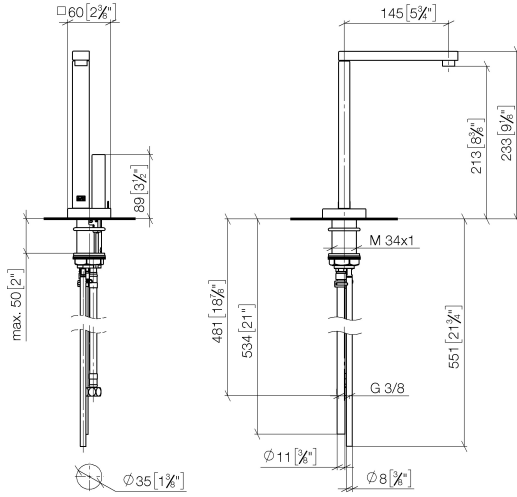

Flow rate chart



Certificates

IAPMO_N-4976. IAPMO_6397.

17 861 680

