

17 861 875



- 146mm projection
  - rigid, thermally insulated spout
  - laminar flow
  - height of mixer 288 mm
  - height up to laminar flow regulator 180 mm
  - hole diameter 35 mm
  - provides filtered, hot water up to 93°C
  - provides filtered, cold water
  - max. flow 2 l/min at 3 bar flow pressure
  - ready-to-use control unit for wall mounting (137mm x 159mm x 60mm)
  - electronic magnetic valve
  - 100-230 V, 50-60 Hz, 18 W power supply unit, incl. country-specific adapter set
  - lead-free
  - Spout ring cannot be removed.
  - This product can help a building meet the requirements of Green Building Rating Systems, e.g. LEED®, BREEAM®, DGNB
- A minimum flow pressure of 3 bar is necessary for the HOT & COLD WATER DISPENSER to work perfectly in conjunction with a hot water tank and filter.**
- In addition, the installation must be above a kitchen sink.**
- The filter cartridge must be changed every six months. The installation instructions contain further information for guidance.**
- Detailed planning information and technical data can be found at [www.dornbracht.com/professional](http://www.dornbracht.com/professional)**

A minimum flow pressure of 3 bar is necessary for the HOT & COLD WATER DISPENSER to work perfectly in conjunction with a hot water tank and filter.

In addition, the installation must be above a kitchen sink.

The filter cartridge must be changed every six months. The installation instructions contain further information for guidance.

Detailed planning information and technical data can be found at [www.dornbracht.com/professional](http://www.dornbracht.com/professional)

	Brushed Platinum	17 861 875-06
	Chrome	17 861 875-00
	Platinum	17 861 875-08
	Durabronze (23kt Gold)	17 861 875-09
	Dark Chrome	17 861 875-19
	Brushed Durabronze (23kt Gold)	17 861 875-28
	Matte Black	17 861 875-33
	Brushed Champagne (22kt Gold)	17 861 875-46
	Champagne (22kt Gold)	17 861 875-47
	Brushed Chrome	17 861 875-93
	Brushed Dark Platinum	17 861 875-99

Required miscellaneous



Hot water tank incl. filter - 12 893 970 90

17 861 875

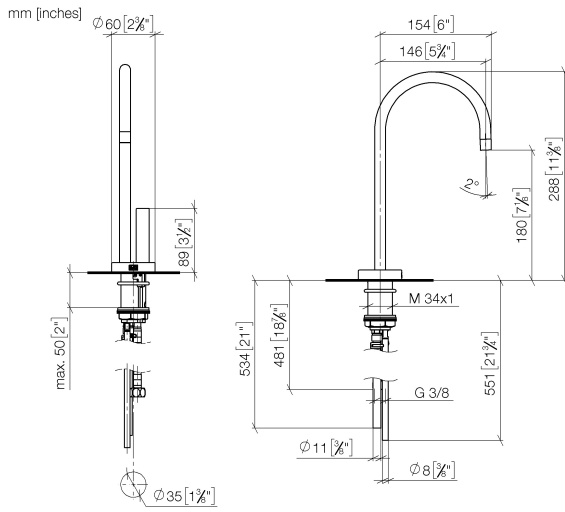

**Flow rate chart**

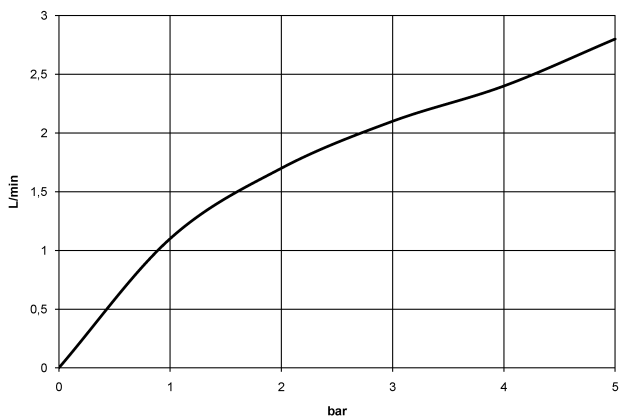

**Codes & Standards**

ASME A112.18.1	cUPC	DIN 4109	Executive Order no. 1007
ISO 3822	NSF372	NSF61	Ü-Zeichen



TARA ULTRA HOT & COLD WATER DISPENSER - Brushed Platinum

TARA ULTRA

17 861 875

Certificates

GDV\_0400

IAPMO\_4976

IAPMO\_N-4

LGA\_28

IAPMO\_6

17 861 875

Product version from 4/1/2014 to 5/27/2021

Product version from 5/27/2021 to 5/28/2022

**Product version from 5/28/2022**

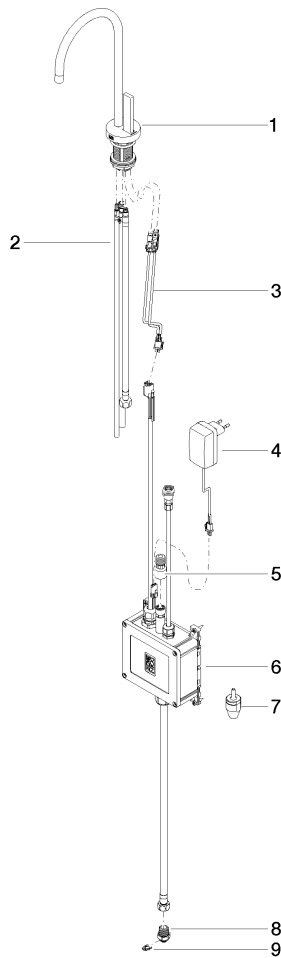



# TARA ULTRA HOT & COLD WATER DISPENSER - Brushed Platinum

TARA ULTRA

17 861 875

## Spare parts list

Product version from 4/1/2014 to 5/27/2021

Product version from 5/27/2021 to 5/28/2022

### Product version from 5/28/2022

No.	Item Number	Name	Quantity used	Delivery time
	90 17 85 100 05-06	fitting	9	10