

20 713 819



- 168mm projection
- pivotable spout 360°
- circular, air-enriched flow
- height of mixer 280 mm
- height up to aerator 191 mm
- hole diameter valve 32 mm
- hole diameter spout 35 mm
- rosette Ø 60 mm
- max. flow 5.7 l/min
- lead-free
- This product can help a building meet the requirements of Green Building Rating Systems, e.g. LEED®, BREEAM®, DGNB
- WRAS 2312068

Only suitable for basins with an overflow.

	Dark Chrome	20 713 819-19
	Chrome	20 713 819-00
	Brushed Platinum	20 713 819-06
	Platinum	20 713 819-08
	Brushed Durabronze (23kt Gold)	20 713 819-28
	Brushed Bronze	20 713 819-42
	Brushed Champagne (22kt Gold)	20 713 819-46
	Champagne (22kt Gold)	20 713 819-47
	Brushed Dark Platinum	20 713 819-99

20 713 819

mm [inches]

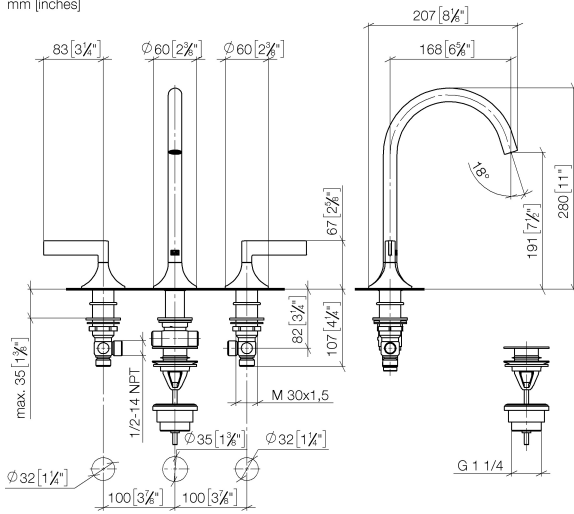

Flow rate chart



Certificates

LGA_29292.

GDV_0400287.

WRAS_2312068.

20 713 819

Parts for other finishes can be found here: [Chrome](#)

