







IMO Single-hole basin mixer with stand pipe without pop-up waste - Brushed Dark Platinum

IMO

22 585 671



- 195mm projection
- fixed spout
- rectangular, air-enriched flow
- total height 1038 - 1103 mm
- height up to aerator 970 – 1040 mm
- rosette Ø 135 mm
- max. flow 4.6 l/min
- lead-free
- This product can help a building meet the requirements of Green Building Rating Systems, e.g. LEED®, BREEAM®, DGNB

	Brushed Dark Platinum	22 585 671-99
	Chrome	22 585 671-00
	Brushed Platinum	22 585 671-06
	Dark Chrome	22 585 671-19
	Brushed Light Gold	22 585 671-27
	Matte Black	22 585 671-33
	Brushed Chrome	22 585 671-93

Required miscellaneous



- Concealed floor mounting -**
- min. recess depth 80 mm
 - max. recess depth 150 mm

35 945 970 90

Required miscellaneous



- Concealed floor mounting -**
- min. recess depth 80 mm
 - max. recess depth 150 mm

35 945 970 90

**IMO Single-hole basin mixer with stand pipe without pop-up waste - Brushed
Dark Platinum**

IMO

22 585 671
mm [inches]

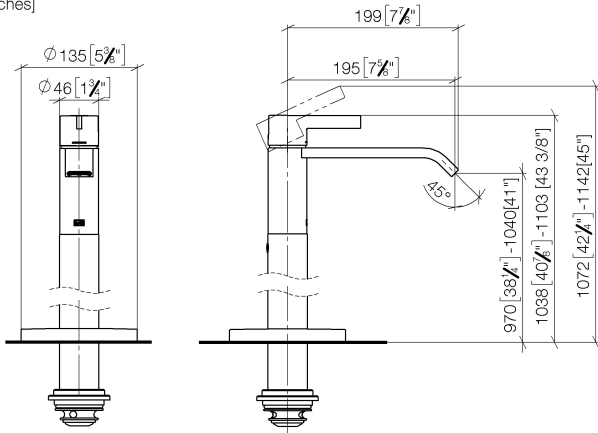

Flow rate chart

