

MADISON Bath mixer for wall mounting with hand shower set - Brushed Dark Platinum







MADISON

25 023 360



- 160mm projection
- Hand shower: COMPACT RAIN, max. flow rate 9 l/min (at 3 bar)
- spout: rectangular normal flow
- wall bracket
- rotary diverter for bath/shower
- rosette Ø 70 mm
- 1/2" connection
- gauge 153 mm
- metal shower hose 1250mm with integrated anti-twist protection
- max. spout flow rate 26 l/min

Intrinsic protection against back flow.

	Brushed Dark Platinum	25 023 360-99
	Chrome	25 023 360-00
	Brushed Platinum	25 023 360-06
	Platinum	25 023 360-08
	Durabass (23kt Gold)	25 023 360-09
	Brushed Durabass (23kt Gold)	25 023 360-28

25 023 360
mm [inches]

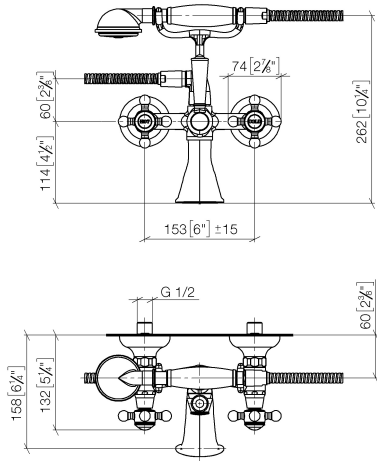

Flow rate chart



Certificates

WRAS_1512014. Belgaqua_21-378-
27_2.

25 023 360
Parts for other
finishes can be found
here: [Chrome](#)

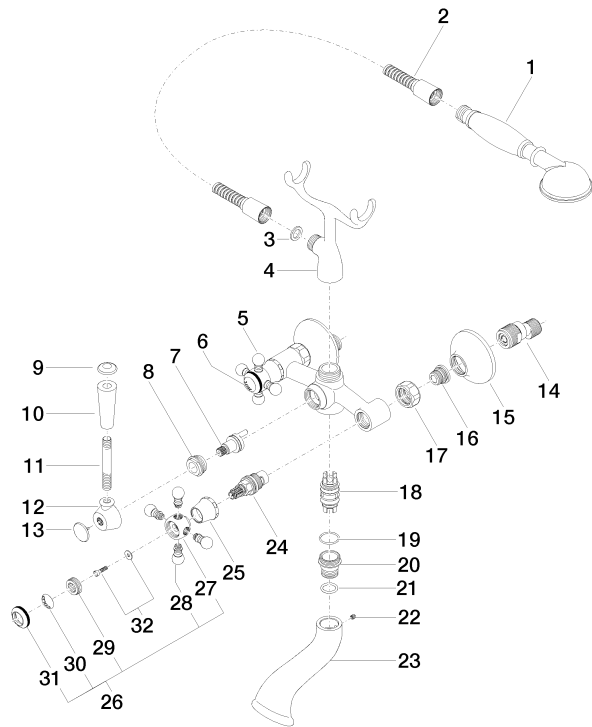

MADISON Bath mixer for wall mounting with hand shower set - Brushed Dark Platinum

MADISON

25 023 360

Spare parts list

No.	Item Number	Name	Quantity used	Delivery time
1	28 002 970-99	MADISON Metal hand shower with porcelain insert (white) - Brushed Dark Platinum	1	30
2	28 104 970-99	Metal shower hose 1/2" x 1/2" x 1250 mm - Brushed Dark Platinum	1	2
3	90 14 20 002 00 90	seal	1	2
4	04 17 20 010 00-99	holder	1	30
5	04 20 36 002 07-99	handle (hot)	1	30
6	09 26 01 011 90	accessories	1	2
7	90 15 01 001 00 90	diverter	1	2
8	09 23 10 007 90	nut	1	2
9	09 30 30 062-99	screw	1	30
10	11 170 370-99	MADISON Lever insert - Brushed Dark Platinum	1	30
11	09 28 22 013 90	pipe	1	2
12	09 18 20 011-99	base	1	30
13	09 30 30 064-99	screw	1	30
14	04 11 04 030 00 90	connection	2	2
15	09 27 39 010-99	rosette	2	30
16	04 29 05 014 00 90	nipple	2	2
17	09 23 30 010-99	nut	2	30
18	90 21 10 010 00 90	insert	1	2
19	90 14 10 056 00 90	seal	1	2
20	09 24 03 123 20 90	nipple	1	2
21	09 14 10 022 90	seal	1	2
22	90 31 11 030 00 90	pin	1	2
23	09 11 06 033 20-99	spout	1	30
24	90 90 03 131 00 90	top	2	2
25	09 21 02 055-99	cover	2	30
26	04 20 36 002 06-99	handle (cold)	1	30
27	09 20 36 002-99	handle	2	30
28	09 20 36 004-99	handle	8	30
29	09 20 83 006 90	handle	2	2
30	09 26 01 010 90	accessories	1	2
31	09 20 36 005-99	handle	2	30
32	04 30 30 029 00 90	fixing set	2	2