





CYO Single-lever bath mixer with stand pipe for free-standing assembly with hand shower set - Brushed Platinum

CYO

25 863 811



- 253mm projection
- rectangular, air-enriched flow
- max. spout flow rate 26.5 l/min
- Hand shower: COMPACT RAIN, max. flow rate 6.8 l/min (at 3 bar)
- bar-type hand shower with anti-scale system
- wall bracket
- automatic bath/shower diverter
- total height 980 - 1050 mm
- stand pipe height 598 - 668 mm
- height up to aerator 903 – 973 mm
- push-on rosette 131 x 131 mm
- metal shower hose 1250mm with integrated anti-twist protection

	Brushed Platinum	25 863 811-06
	Chrome	25 863 811-00
	Dark Chrome	25 863 811-19
	Brushed Durabrass (23kt Gold)	25 863 811-28
	Brushed Dark Platinum	25 863 811-99

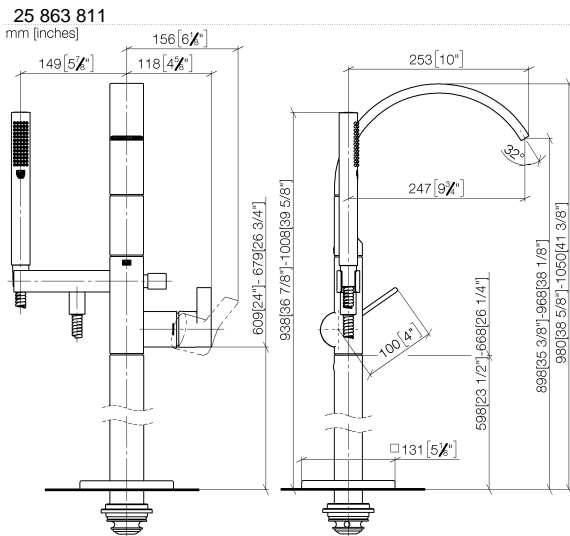

Flow rate chart

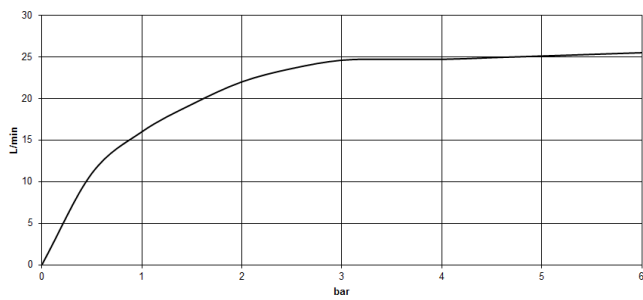

Certificates

IAPMO_4976 (6). LGA_38119. WRAS_2201043. Belgaqua_21-376-27_1.

CYO Single-lever bath mixer with stand pipe for free-standing assembly with hand shower set - Brushed Platinum

CYO

25 863 811

Parts for other finishes can be found here: [Chrome](#)

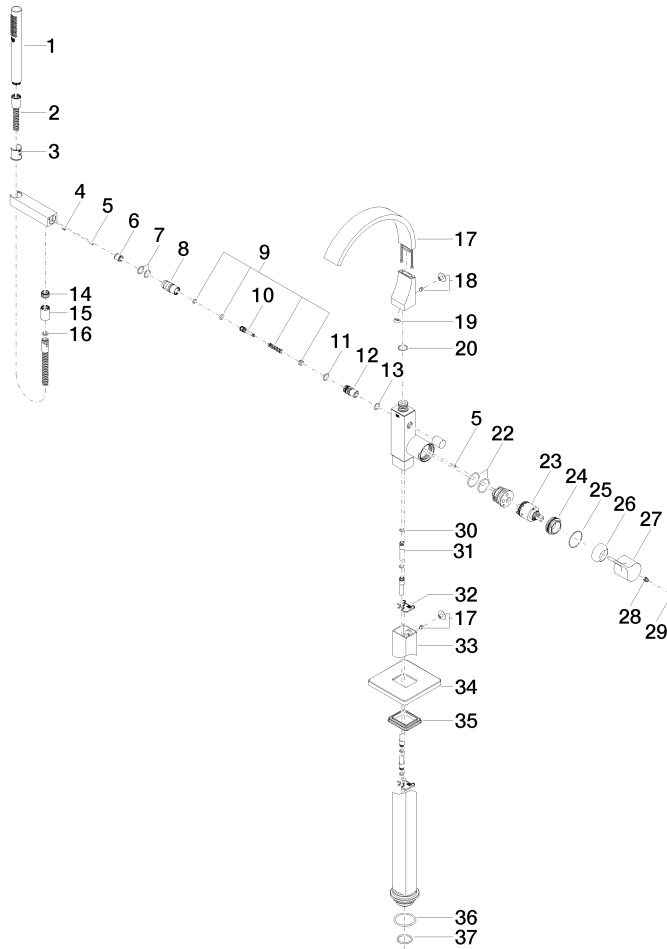



CYO Single-lever bath mixer with stand pipe for free-standing assembly with hand shower set - Brushed Platinum

CYO

25 863 811

Spare parts list

No.	Item Number	Name	Quantity used	Delivery time
1	90 12 11 140 30-06	shower	1	10
2	90 30 02 072 00-06	Metal shower hose 1/2" x 3/8" x 1250 mm - Brushed Platinum	1	10
3	09 18 40 118 90	sleeve	1	2
4	09 31 11 058 90	pin	1	2
5	09 31 11 040 90	pin	3	2
6	90 23 01 141 00 90	back-flow preventer	1	2
7	90 14 10 010 00 90	seal	2	2
8	09 24 03 130-00	nipple	1	10
9	90 16 02 023 00 90	spring	1	2
10	09 31 09 094 20-06	pull-rod	1	10
11	90 14 10 055 00 90	seal	1	2
12	09 21 34 080-06	nipple	1	10
13	90 14 10 033 00 90	seal	1	2
14	09 24 03 069 90	nipple	1	2
15	90 21 02 069 00-06	cover	1	10
16	90 14 20 026 00 90	seal	1	2
17	90 11 70 011 00-06	spout	1	10
18	04 31 20 034 00 90	plug	2	2
19	09 23 01 057 90	flow reducer	1	2
20	09 14 10 031 90	seal	2	2
21	09 14 10 148 90	seal	1	2
22	90 15 05 039 00 90	cartridge	1	2
23	09 24 04 298 90	nut	1	2
24	09 14 10 037 90	seal	1	2
25	09 28 30 036-06	cover	1	10
26	09 20 80 022-06	handle	1	10
27	90 31 11 030 00 90	pin	1	2
28	90 31 20 087 00-06	plug	1	10
29	09 14 10 139 90	seal	4	2
30	04 28 22 025 00 90	connection	2	2
31	09 20 93 051 90	holder	2	2
32	04 28 22 024 00-06	pipe	1	10
33	09 27 71 011-06	rosette	1	10
34	09 14 03 107 90	seal	1	2
35	09 14 10 084 90	seal	1	2
36	09 14 10 018 90	seal	1	2