





27 512 882



- spout: circular, air-enriched flow
- max. flow 23.5 l/min at 3 bar flow pressure
- Hand shower: COMPACT RAIN, max. flow rate 6.8 l/min (at 3 bar)
- complete hand shower set with anti-scale system
- 220mm projection
- with anti-scale system
- automatic bath/shower diverter
- height of mixer 290 mm
- height up to aerator 135 mm
- hole diameter valve 32 mm
- hole diameter spout 32 mm
- hole diameter for complete hand shower set 32 mm
- rosette for spout Ø 55mm
- rosette for complete hand shower set Ø 50mm
- rosette for deck valve Ø 55mm
- metal shower hose 1750mm with integrated anti-twist protection

Available with 260 mm or 300 mm projection on request (x-TRA SERVICE).

Intrinsic protection against back flow.

	Dark Chrome	27 512 882-19
	Chrome	27 512 882-00
	Brushed Platinum	27 512 882-06
	Platinum	27 512 882-08
	Brushed Durabronze (23kt Gold)	27 512 882-28
	Matte Black	27 512 882-33
	Brushed Champagne (22kt Gold)	27 512 882-46
	Champagne (22kt Gold)	27 512 882-47
	Brushed Chrome	27 512 882-93
	Brushed Dark Platinum	27 512 882-99

27 512 882

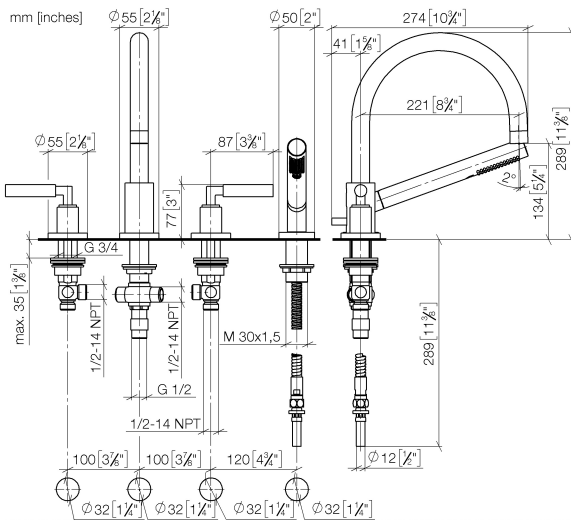

Flow rate chart

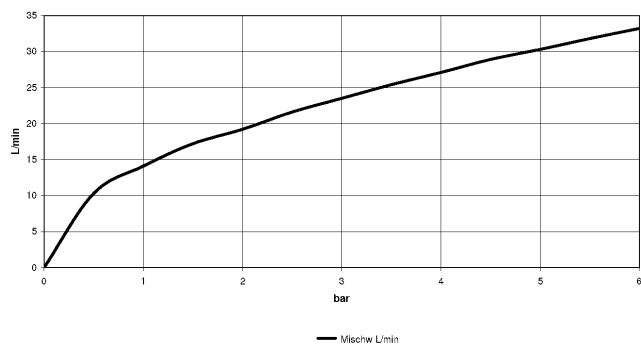

27 512 882

Parts for other
finishes can be found
here: [Chrome](#)

