







27 512 892



- spout: circular, air-enriched flow
- max. flow 23.5 l/min at 3 bar flow pressure
- Hand shower: COMPACT RAIN, max. flow rate 6.8 l/min (at 3 bar)
- complete hand shower set with anti-scale system
- 220mm projection
- automatic bath/shower diverter
- height of mixer 290 mm
- height up to aerator 135 mm
- hole diameter spout 32 mm
- hole diameter valve 32 mm
- hole diameter for complete hand shower set 32 mm
- rosette for spout Ø 55mm
- rosette for complete hand shower set Ø 50mm
- rosette for deck valve Ø 55mm
- metal shower hose 2250mm with integrated anti-twist protection

Also available with 260 mm or 300 mm projection on request (x-TRA SERVICE).

Intrinsic protection against back flow.

	Brushed Chrome	27 512 892-93
	Chrome	27 512 892-00
	Brushed Platinum	27 512 892-06
	Platinum	27 512 892-08
	Dark Chrome	27 512 892-19
	Brushed Durabronze (23kt Gold)	27 512 892-28
	Matte Black	27 512 892-33
	Brushed Champagne (22kt Gold)	27 512 892-46
	Champagne (22kt Gold)	27 512 892-47
	Brushed Dark Platinum	27 512 892-99

**Recommended miscellaneous**



**Perfecto installation kit -**

12 614 970 90

27 512 892

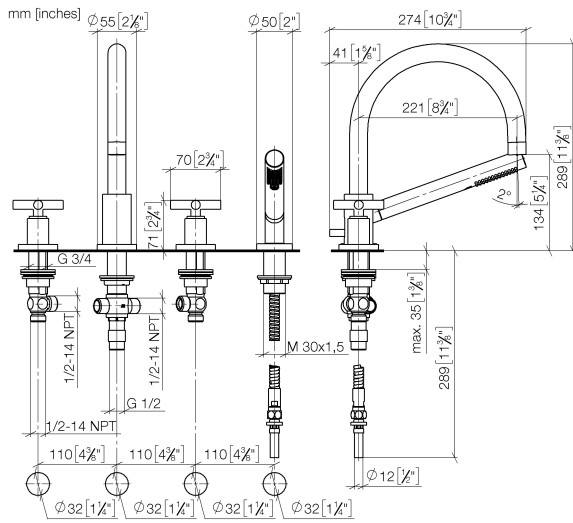

Flow rate chart

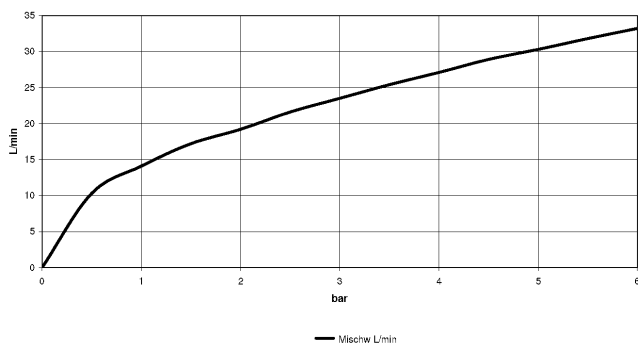

Certificates

IAPMO\_4976 (2).      LGA\_18926.      Belgaqua\_21-026-27\_4.

27 512 892

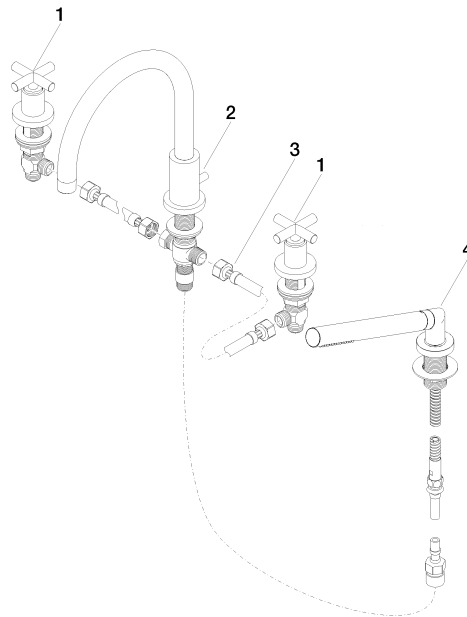

### Spare parts list

No.	Item Number	Name	Quantity used	Delivery time
1	20 000 892-93	TARA Deck valve clockwise closing cold or hot - Brushed Chrome	2	20
2	13 512 892-93	spout	1	-
Spare part can no longer be ordered, please order the replacement item				
3	12 502 970 90	High pressure hose 1/2" x 1/2" x 400 mm -	1	2
4	27 702 979-93	Hand shower set for bath rim or tile edge installation - Brushed Chrome	1	20