

27 532 782



- 220mm projection
- spout: rectangular normal flow
- max. flow 27.3 l/min at 3 bar flow pressure
- Hand shower: COMPACT RAIN, max. flow rate 6.8 l/min (at 3 bar)
- complete hand shower set with anti-scale system
- automatic bath/shower diverter
- height of mixer 300 mm
- height up to aerator 170 mm
- hole diameter valve 32 mm
- hole diameter spout 32 mm
- hole diameter for complete hand shower set 32 mm
- rosette for spout 60 x 60mm
- rosette for complete hand shower set 60 x 60mm
- rosette for deck valve 60 x 60mm
- metal shower hose 1750mm with integrated anti-twist protection
- WRAS 2306058

Intrinsic protection against back flow.

	Brushed Platinum	27 532 782-06
	Chrome	27 532 782-00
	Platinum	27 532 782-08
	Dark Chrome	27 532 782-19
	Brushed Durabrass (23kt Gold)	27 532 782-28
	Brushed Champagne (22kt Gold)	27 532 782-46
	Champagne (22kt Gold)	27 532 782-47
	Brushed Dark Platinum	27 532 782-99

Recommended miscellaneous



Perfecto installation kit - 12 614 970 90

Recommended miscellaneous



Decorative caps for Perfecto - Brushed Platinum 12 801 970-06
• 1 pair

27 532 782

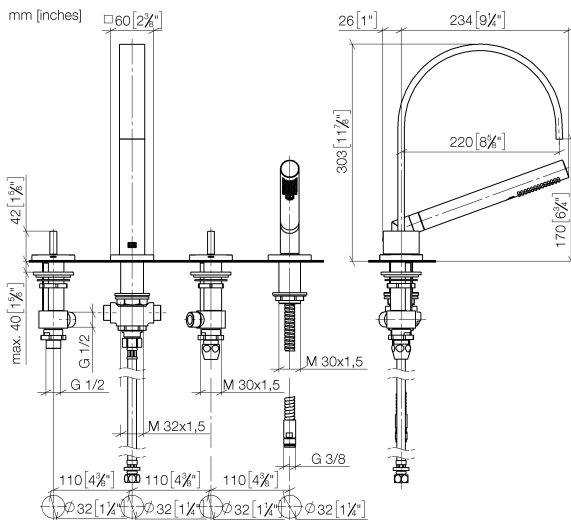

Flow rate chart

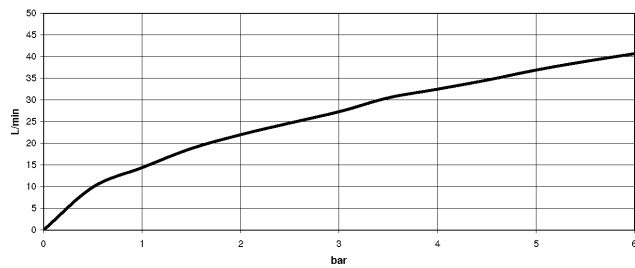

Certificates

IAPMO_4976 (5). WRAS_2306058. LGA_9681. Belgaqua_21-026-27_4.

27 532 782

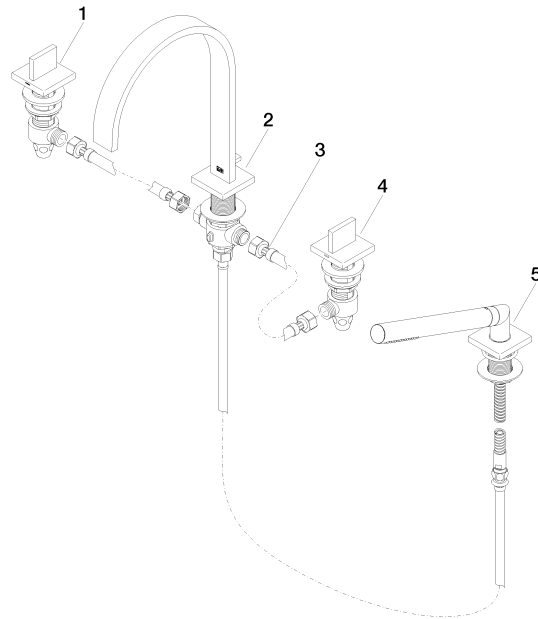

Spare parts list

No.	Item Number	Name	Quantity used	Delivery time
1	20 000 783-06	MEM Deck valve anti-clockwise closing hot - Brushed Platinum	1	10
2	13 512 782-06	spout	1	60
3	12 502 970 90	High pressure hose 1/2" x 1/2" x 400 mm -	1	2
4	20 000 782-06	MEM Deck valve clockwise closing cold - Brushed Platinum	1	10
5	27 702 980-06	Hand shower set for bath rim or tile edge installation - Brushed Platinum	1	10