

## Shower head - Brushed Champagne (22kt Gold)









IMO

28 504 670



- 180-210mm projection
- ball-joint pivotable through 30°
- PURIFY RAIN, max. flow rate 7 l/min (at 3 bar)
- with anti-scale system
- spray head Ø 100mm
- rosette 60 x 60 mm
- 1/2" connection
- Function from: 6 l/min

Fits: IMO, MEM, CL.1, CYO

|   |                               |               |
|---|-------------------------------|---------------|
|    | Brushed Champagne (22kt Gold) | 28 504 670-46 |
|    | Chrome                        | 28 504 670-00 |
|    | Brushed Platinum              | 28 504 670-06 |
|    | Platinum                      | 28 504 670-08 |
|    | Dark Chrome                   | 28 504 670-19 |
|    | Brushed Light Gold            | 28 504 670-27 |
|    | Brushed Durabrass (23kt Gold) | 28 504 670-28 |
|    | Matte Black                   | 28 504 670-33 |
|   | Champagne (22kt Gold)         | 28 504 670-47 |
|  | Brushed Chrome                | 28 504 670-93 |
|  | Brushed Dark Platinum         | 28 504 670-99 |

### Recommended miscellaneous



- Concealed wall elbow -**
- max. recess depth 163 mm
  - min. recess depth 90 mm

35 085 970 90

28 504 670

mm [inches]

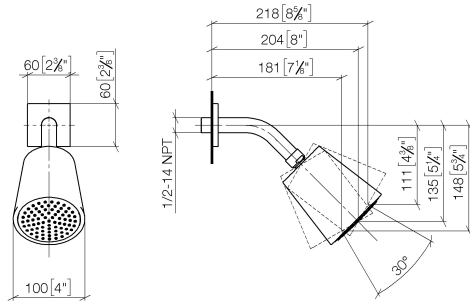

Flow rate chart



Certificates

LGA\_19924.

28 504 670



### Spare parts list

| No. | Item Number        | Name       | Quantity used | Delivery time |
|-----|--------------------|------------|---------------|---------------|
| 1   | 09 27 98 003-46    | rosette    | 1             | 30            |
| 2   | 09 31 11 048 90    | pin        | 1             | 2             |
| 3   | 90 14 10 026 00 90 | seal       | 1             | 2             |
| 4   | 09 11 03 011-46    | connection | 1             | 30            |
| 5   | 90 14 20 002 00 90 | seal       | 1             | 2             |
| 6   | 90 12 05 054 00-46 | shower     | 1             | 30            |