

## Shower head - Platinum













TARA

28 504 979



- 180-210mm projection
- ball-joint pivotable through 30°
- PURIFY RAIN, max. flow rate 7 l/min (at 3 bar)
- Function from: 6 l/min
- with anti-scale system
- spray head Ø 100mm
- rosette Ø 55 mm
- 1/2" connection

Fits: TARA, LISSÉ, VAIA, META

|   |                                     |               |
|---|-------------------------------------|---------------|
|    | Platinum                            | 28 504 979-08 |
|    | Chrome                              | 28 504 979-00 |
|    | Brushed Platinum                    | 28 504 979-06 |
|    | Dark Chrome                         | 28 504 979-19 |
|    | Light Gold                          | 28 504 979-26 |
|    | Brushed Light Gold                  | 28 504 979-27 |
|    | Brushed Durabrass<br>(23kt Gold)    | 28 504 979-28 |
|    | Matte Black                         | 28 504 979-33 |
|    | Brushed Bronze                      | 28 504 979-42 |
|  | Brushed<br>Champagne (22kt<br>Gold) | 28 504 979-46 |
|  | Champagne (22kt<br>Gold)            | 28 504 979-47 |
|  | Brushed Chrome                      | 28 504 979-93 |
|  | Brushed Dark<br>Platinum            | 28 504 979-99 |

### Recommended miscellaneous



- Concealed wall elbow -** 35 085 970 90
- max. recess depth 163 mm
  - min. recess depth 90 mm

28 504 979

mm [inches]

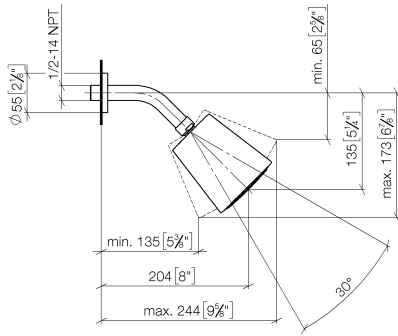

Flow rate chart

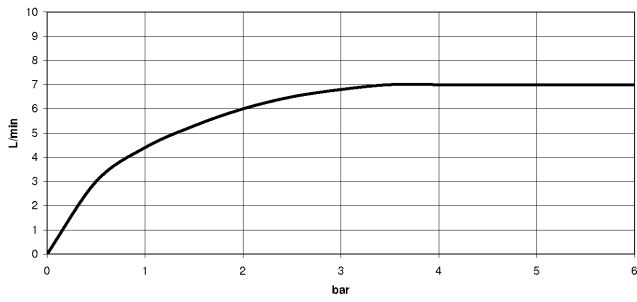

Certificates

DVGW\_DW- LGA\_19924.  
6517DN0118.

28 504 979

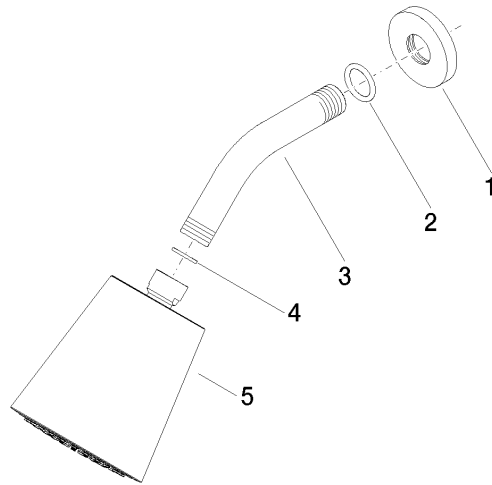

### Spare parts list

| No. | Item Number        | Name       | Quantity used | Delivery time |
|-----|--------------------|------------|---------------|---------------|
| 1   | 09 27 22 003-08    | rosette    | 1             | 40            |
| 2   | 90 14 10 026 00 90 | seal       | 1             | 2             |
| 3   | 09 11 03 011-08    | connection | 1             | 40            |
| 4   | 90 14 20 002 00 90 | seal       | 1             | 2             |
| 5   | 90 12 05 054 00-08 | shower     | 1             | 40            |