

Rain shower with wall fixing FlowReduce 220 mm - Brushed Chrome











IMO

28 648 670



Fits: IMO, CYO

- 450mm projection
- rain shower Ø 220 mm
- rain flow
- max. flow 7 l/min
- Function from: 6 l/min
- rosette 65 x 65 mm
- 1/2" connection
- with anti-scale system
- quick clearing
- This product can help a building meet the requirements of Green Building Rating Systems, e.g. LEED®, BREEAM®, DGNB

	Brushed Chrome	28 648 670-93
	Chrome	28 648 670-00
	Brushed Platinum	28 648 670-06
	Platinum	28 648 670-08
	Dark Chrome	28 648 670-19
	Brushed Light Gold	28 648 670-27
	Brushed Durabrass (23kt Gold)	28 648 670-28
	Matte Black	28 648 670-33
	Brushed Champagne (22kt Gold)	28 648 670-46
	Champagne (22kt Gold)	28 648 670-47
	Brushed Dark Platinum	28 648 670-99

28 648 670

mm [inches]



### Flow rate chart



### Certificates

LGA\_38655.

28 648 670

Parts for other finishes can be found here: [Chrome](#)

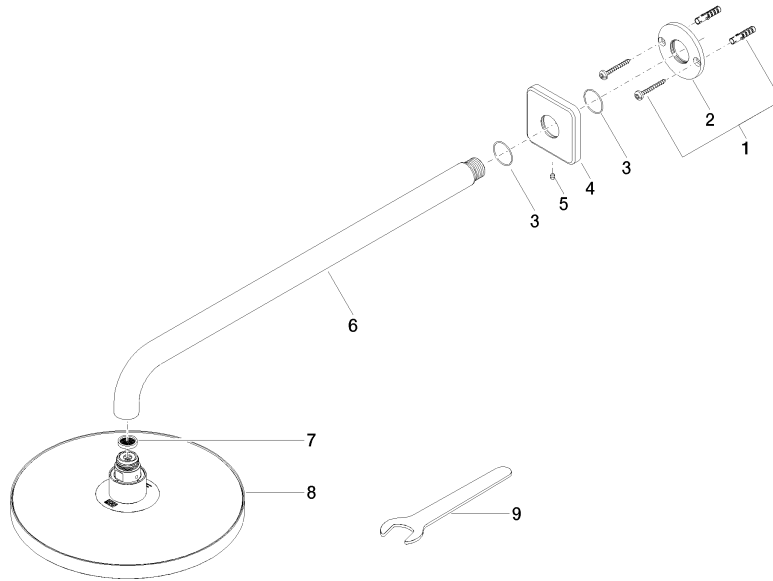

### Spare parts list

No.	Item Number	Name	Quantity used	Delivery time
1	04 30 31 032 00 90	fixing set	1	2
2	09 17 20 120 90	holder	1	2
3	09 14 10 150 90	seal	1	2
4	09 27 67 015-93	rosette	1	20
5	90 31 11 038 00 90	pin	1	2
6	90 11 03 070 00-93	pipe	1	20
7	09 23 01 075 90	insert	1	2
8	90 12 05 092 20-93	shower	1	20
9	90 30 09 069 00 90	key	1	2