

**Rain shower with wall fixing 220 mm - Brushed Champagne (22kt Gold)**











IMO

28 649 670



- 450mm projection
- rain shower Ø 220 mm
- PURE RAIN, max. flow rate 14 l/min (at 3 bar)
- Function from: 7 l/min
- rosette 65 x 65 mm
- 1/2" connection
- with anti-scale system
- quick clearing
- WRAS 2212012

Fits: IMO, CYO

	Brushed Champagne (22kt Gold)	28 649 670-46
	Chrome	28 649 670-00
	Brushed Platinum	28 649 670-06
	Platinum	28 649 670-08
	Dark Chrome	28 649 670-19
	Brushed Light Gold	28 649 670-27
	Brushed Durabrass (23kt Gold)	28 649 670-28
	Matte Black	28 649 670-33
	Champagne (22kt Gold)	28 649 670-47
	Brushed Chrome	28 649 670-93
	Brushed Dark Platinum	28 649 670-99

**Recommended miscellaneous**



- Concealed wall elbow -**
- max. recess depth 163 mm
  - min. recess depth 90 mm

35 085 970 90

28 649 670

mm [inches]

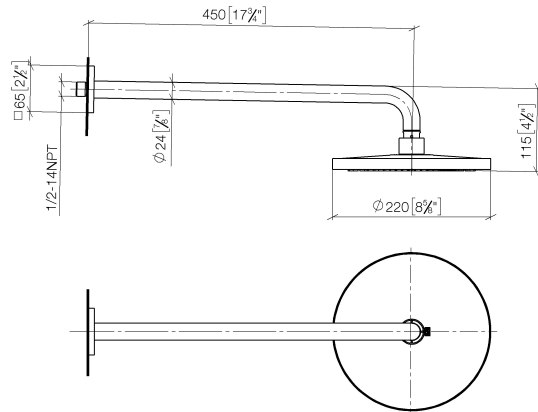

Flow rate chart

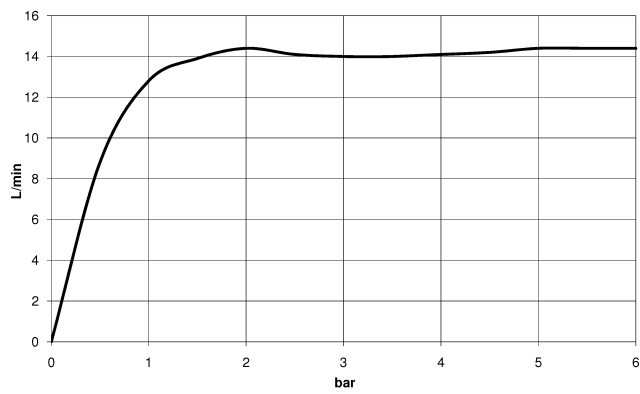

Certificates

WRAS\_2212012. LGA\_38655.

28 649 670

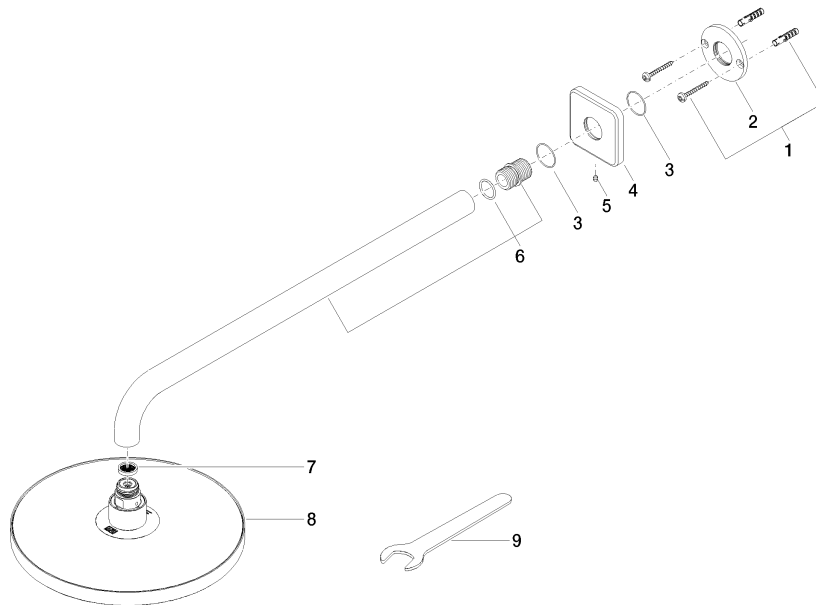

### Spare parts list

No.	Item Number	Name	Quantity used	Delivery time
1	04 30 31 032 00 90	fixing set	1	2
2	09 17 20 120 90	holder	1	2
3	09 14 10 150 90	seal	2	2
4	09 27 67 015-46	rosette	1	30
5	90 31 11 038 00 90	pin	1	2
6	90 11 03 070 00-46	pipe	1	30
7	09 23 01 075 90	insert	1	2
8	04 12 05 092 00-46	shower	1	60
9	90 30 09 069 00 90	key	1	2