

Rain shower with wall fixing 300 mm - Brushed Platinum













TARA

28 679 970



- 450mm projection
- rain shower Ø 300 mm
- PURE RAIN, max. flow rate 14 l/min (at 3 bar)
- Function from: 10 l/min
- rosette Ø 60 mm
- 1/2" connection
- with anti-scale system
- quick clearing
- WRAS 2212012

Fits: TARA, LISSÉ, VAIA, META

	Brushed Platinum	28 679 970-06
	Chrome	28 679 970-00
	Platinum	28 679 970-08
	Dark Chrome	28 679 970-19
	Light Gold	28 679 970-26
	Brushed Light Gold	28 679 970-27
	Brushed Durabronze (23kt Gold)	28 679 970-28
	Matte Black	28 679 970-33
	Brushed Bronze	28 679 970-42
	Brushed Champagne (22kt Gold)	28 679 970-46
	Champagne (22kt Gold)	28 679 970-47
	Brushed Chrome	28 679 970-93
	Brushed Dark Platinum	28 679 970-99

Recommended miscellaneous



- Concealed wall elbow -** 35 085 970 90
- max. recess depth 163 mm
 - min. recess depth 90 mm

28 679 970

mm [inches]



Flow rate chart



Codes & Standards

DIN 4109

EN 1112

ISO 3822

Scottish Water
Byelaws

UK Water Supply
Regulations

Ü-Zeichen



Rain shower with wall fixing 300 mm - Brushed Platinum

TARA

28 679 970

Certificates

LGA_29

DVGW_DW-
6517DN0

WRAS_2212

28 679 970

Product version from 3/13/2017

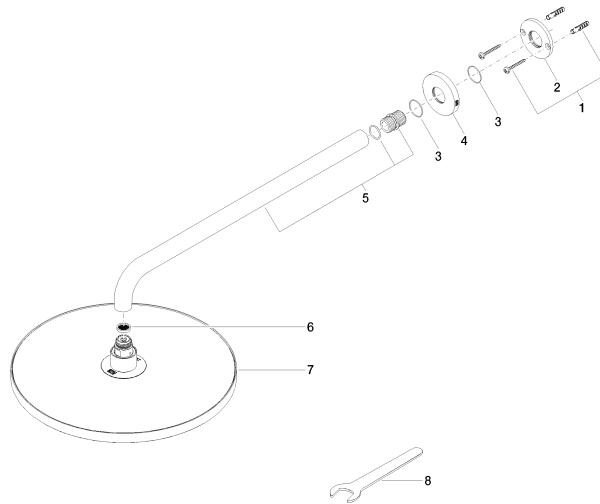



Rain shower with wall fixing 300 mm - Brushed Platinum

TARA

28 679 970

Spare parts list

Product version from 3/13/2017

No.	Item Number	Name	Quantity used	Delivery time
	04 30 31 032 00 90	fixing set	9	2