

Two-way diverter for bath rim or tile edge installation - Brushed Champagne (22kt Gold)

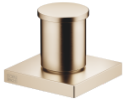









IMO

29 140 670



- automatic bath/shower diverter
- hole diameter 32 mm
- rosette 60 x 60 mm
- 1/2" connection
- max. flow 64.9 l/min at 3 bar flow pressure
- WRAS 1911025

Fits: IMO, MEM, CYO

	Brushed Champagne (22kt Gold)	29 140 670-46
	Chrome	29 140 670-00
	Brushed Platinum	29 140 670-06
	Platinum	29 140 670-08
	Dark Chrome	29 140 670-19
	Brushed Light Gold	29 140 670-27
	Brushed Durabrass (23kt Gold)	29 140 670-28
	Matte Black	29 140 670-33
	Champagne (22kt Gold)	29 140 670-47
	Brushed Chrome	29 140 670-93
	Brushed Dark Platinum	29 140 670-99

Two-way diverter for bath rim or tile edge installation - Brushed Champagne
(22kt Gold)

29 140 670
mm [inches]

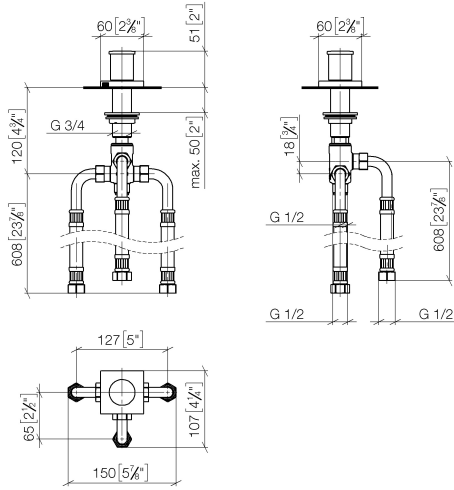

Flow rate chart

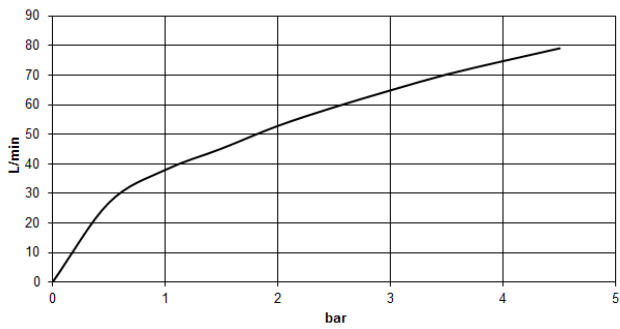

**Two-way diverter for bath rim or tile edge installation - Brushed Champagne
(22kt Gold)**

IMO

29 140 670
Parts for other
finishes can be found
here: [Chrome](#)

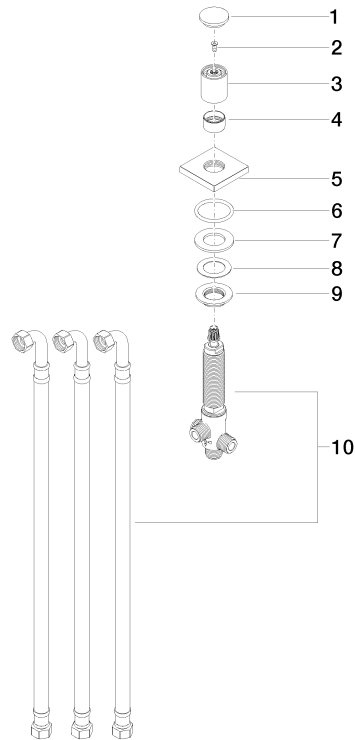

Spare parts list

No.	Item Number	Name	Quantity used	Delivery time
1	09 20 71 003-46	handle	1	30
2	90 30 30 014 00 90	screw	1	2
3	09 20 71 002-46	handle	1	30
4	09 16 01 012-46	ring	1	30
5	09 27 67 006-46	rosette	1	30
6	90 14 10 043 00 90	seal	1	2
7	09 14 05 014 90	seal	1	2
8	09 14 40 002 90	seal	1	2
9	09 23 10 004 90	nut	1	2
10	90 17 09 051 00 90	diverter	1	2