











32 815 861



- 235mm projection
- pivotable spout 360°
- Optional swivel limiter available with swivel limiter set 12 820 970 90
- air-enriched flow
- max. flow 8 l/min at 3 bar flow pressure
- This product can help a building meet the requirements of Green Building Rating Systems, e.g. LEED®, BREEAM®, DGNB
- lead-free
- WRAS 240102014

Operating unit can be positioned freely.

	Brushed Chrome	32 815 861-93
	Chrome	32 815 861-00
	Brushed Platinum	32 815 861-06
	Platinum	32 815 861-08
	Durabronze (23kt Gold)	32 815 861-09
	Dark Chrome	32 815 861-19
	Brushed Durabronze (23kt Gold)	32 815 861-28
	Matte Black	32 815 861-33
	Brushed Champagne (22kt Gold)	32 815 861-46
	Champagne (22kt Gold)	32 815 861-47
	Brushed Dark Platinum	32 815 861-99

Recommended miscellaneous

Swivel limitation set - 12 820 970 90



Recommended miscellaneous

Strainer waste with control handle - Brushed Chrome 10 710 970-93



Recommended miscellaneous

Dispenser with rosette - Brushed Chrome 82 444 970-93



32 815 861

mm [inches]
1:5

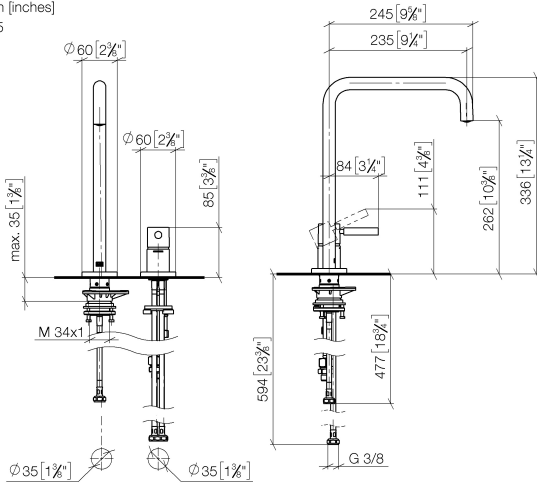

Flow rate chart

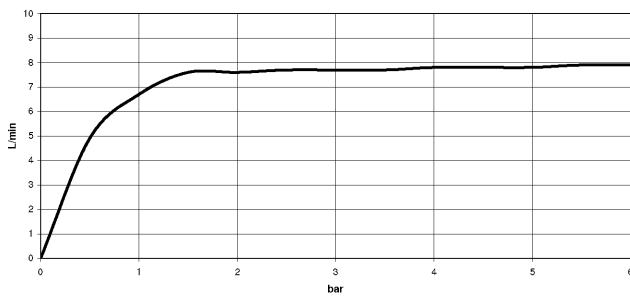

Codes & Standards

DIN 4109

ISO 3822

Scottish Water
Byelaws

UK Water Supply
Regulations

Ü-Zeichen



META SQUARE Two-hole mixer with individual rosettes - Brushed Chrome

META SQUARE

32 815 861

Certificates

WRAS_240102

LGA_38

32 815 861

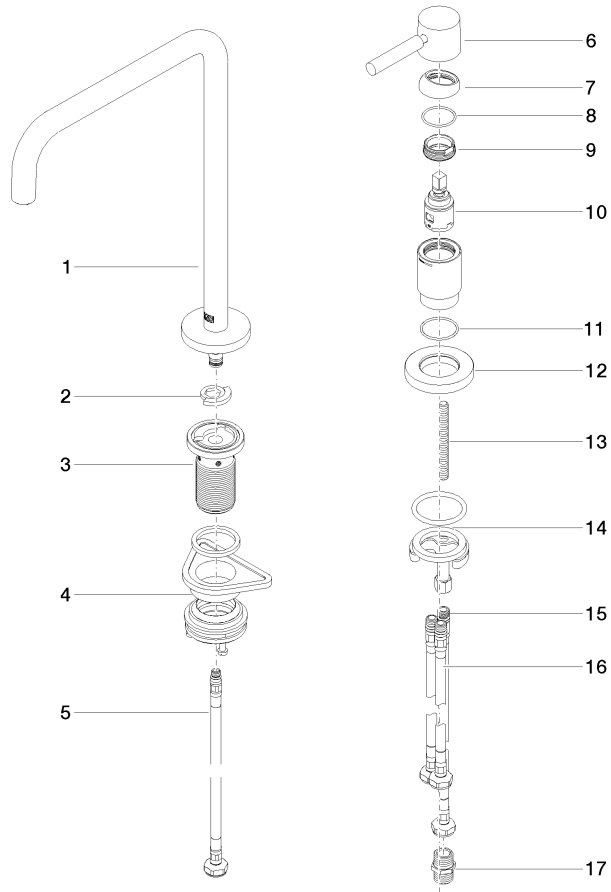



META SQUARE Two-hole mixer with individual rosettes - Brushed Chrome

META SQUARE

32 815 861

Spare parts list

No.	Item Number	Name	Quantity used	Delivery time
	90 28 22 287 00-93	spout	18	-

Spare part can no longer be ordered, please order the replacement item