







33 521 845



- 130mm projection
- fixed spout
- circular, air-enriched flow
- height of mixer 127 mm
- height up to aerator 75 mm
- hole diameter 35 mm
- 2x screw-in M 8 x 1 pressure hose, leak-tested
- max. flow 5.7 l/min
- lead-free
- This product can help a building meet the requirements of Green Building Rating Systems, e.g. LEED®, BREEAM®, DGNB
- WRAS 1906074

	Matte Black	33 521 845-33
	Chrome	33 521 845-00
	Brushed Platinum	33 521 845-06
	Dark Chrome	33 521 845-19
	Brushed Chrome	33 521 845-93
	Brushed Dark Platinum	33 521 845-99

33 521 845

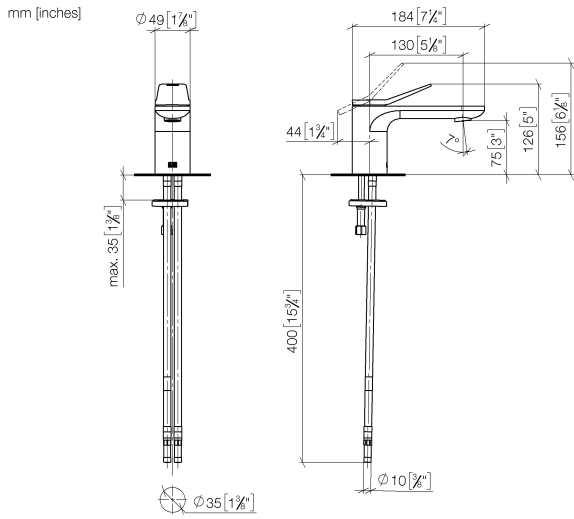

Flow rate chart



Certificates

LGA_29008.

GDV_0400310.

33 521 845

Parts for other
finishes can be found
here: [Chrome](#)

