





IMO Single-lever basin mixer with high spout without pop-up waste - Dark Chrome

IMO

33 526 671



- 165mm projection
- fixed spout
- rectangular, air-enriched flow
- height of mixer 278 mm
- height up to aerator 235 mm
- hole diameter 35 mm
- 2x screw-in M 8 x 1 pressure hose, leak-tested
- max. flow 4.6 l/min
- lead-free
- This product can help a building meet the requirements of Green Building Rating Systems, e.g. LEED®, BREEAM®, DGNB

	Dark Chrome	33 526 671-19
	Chrome	33 526 671-00
	Brushed Platinum	33 526 671-06
	Brushed Light Gold	33 526 671-27
	Matte Black	33 526 671-33
	Brushed Chrome	33 526 671-93
	Brushed Dark Platinum	33 526 671-99

33 526 671

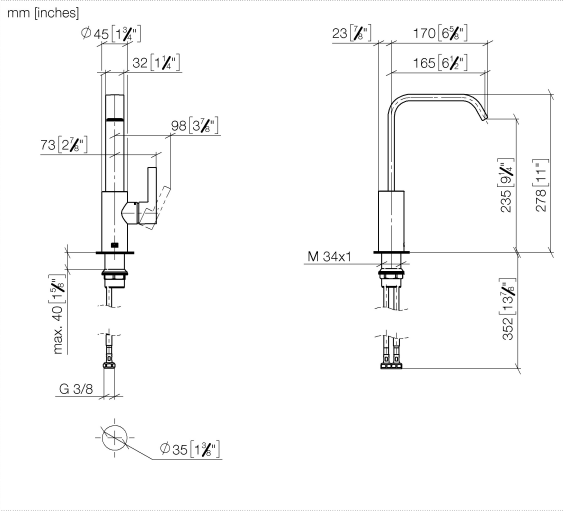

Flow rate chart

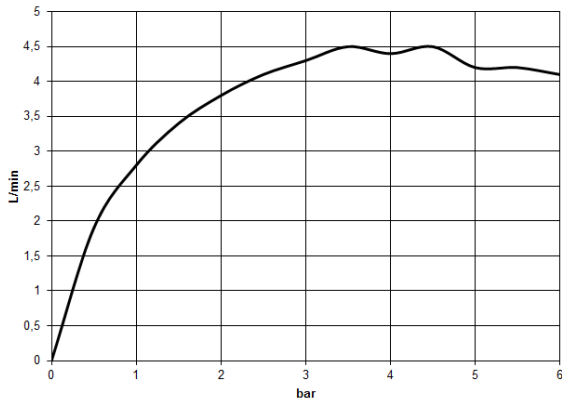

IMO Single-lever basin mixer with high spout without pop-up waste - Dark
Chrome

IMO

33 526 671

Parts for other
finishes can be found
here: [Chrome](#)

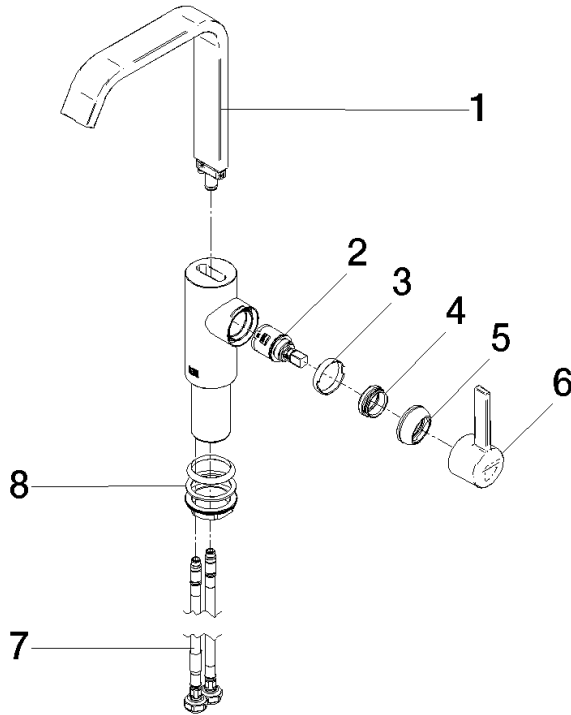



IMO Single-lever basin mixer with high spout without pop-up waste - Dark
Chrome

IMO

33 526 671

Spare parts list