

**IMO Single-lever basin mixer with raised base without pop-up waste - Brushed Platinum**







IMO

33 537 671



- 170mm projection
- fixed spout
- rectangular, air-enriched flow
- height of mixer 298 mm
- height up to aerator 230 mm
- hole diameter 35 mm
- 2x screw-in M 10 x 1 pressure hose, leak-tested
- max. flow 4.6 l/min
- lead-free
- This product can help a building meet the requirements of Green Building Rating Systems, e.g. LEED®, BREEAM®, DGNB

for use on countertop bowls

	Brushed Platinum	33 537 671-06
	Chrome	33 537 671-00
	Dark Chrome	33 537 671-19
	Brushed Light Gold	33 537 671-27
	Matte Black	33 537 671-33
	Brushed Chrome	33 537 671-93
	Brushed Dark Platinum	33 537 671-99

33 537 671  
mm [inches]

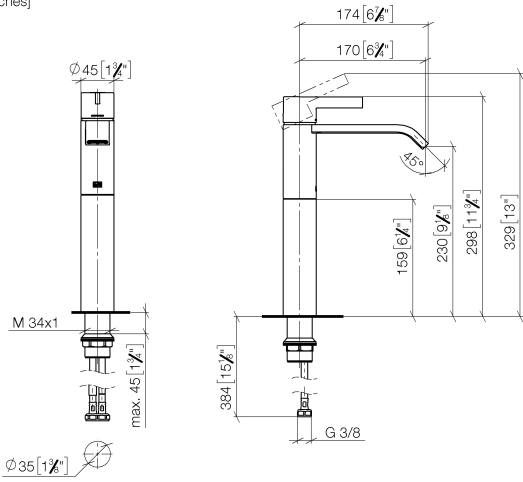

Flow rate chart

