





33 600 845



- 123mm projection
- ball-joint pivotable through 30°
- rectangular, air-enriched flow
- height of mixer 127 mm
- height up to aerator 83 mm
- hole diameter 35 mm
- 2x screw-in M 8 x 1 pressure hose, leak-tested
- max. flow 6 l/min

	Brushed Dark Platinum	33 600 845-99
	Chrome	33 600 845-00
	Brushed Platinum	33 600 845-06
	Dark Chrome	33 600 845-19
	Brushed Chrome	33 600 845-93

Required miscellaneous



High pressure hose 3/8" - 04 30 04 102
 •please order two extra pressure hoses (for the USA only) 00 90

33 600 845

mm [inches]

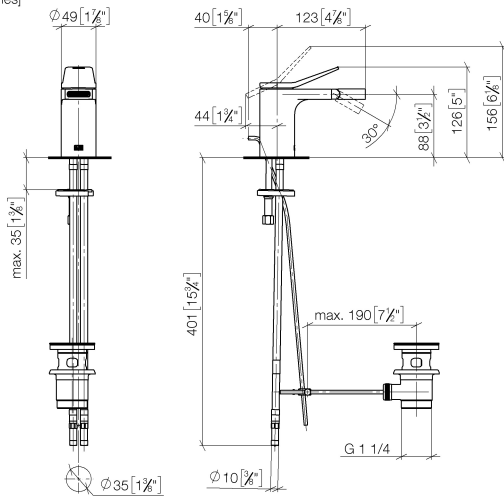

Flow rate chart

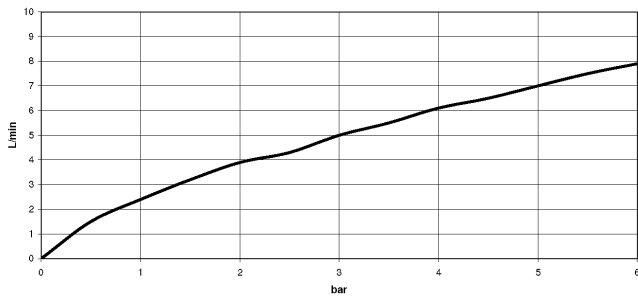

Certificates

LGA_29009.

WRAS_240202012.

33 600 845

