





33 805 875



- 166mm projection
- pivotable spout 360°
- laminar flow
- height of mixer 303 mm
- height up to laminar flow regulator 186 mm
- hole diameter 35 mm
- max. flow 8 l/min at 3 bar flow pressure
- lead-free
- This product can help a building meet the requirements of Green Building Rating Systems, e.g. LEED®, BREEAM®, DGNB

	Brushed Dark Platinum	33 805 875-99
	Chrome	33 805 875-00
	Brushed Platinum	33 805 875-06
	Platinum	33 805 875-08
	Durabronze (23kt Gold)	33 805 875-09
	Dark Chrome	33 805 875-19
	Brushed Durabronze (23kt Gold)	33 805 875-28
	Matte Black	33 805 875-33
	Brushed Champagne (22kt Gold)	33 805 875-46
	Champagne (22kt Gold)	33 805 875-47
	Brushed Chrome	33 805 875-93

Recommended miscellaneous

Strainer waste with control handle - Brushed Dark Platinum 10 712 970-99



Recommended miscellaneous

Dispenser without rosette - Brushed Dark Platinum 82 424 970-99



33 805 875

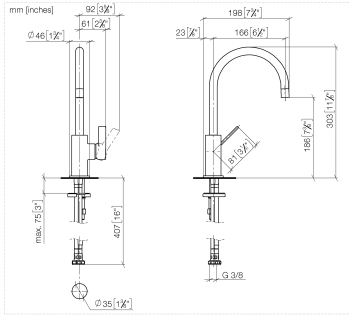

Flow rate chart

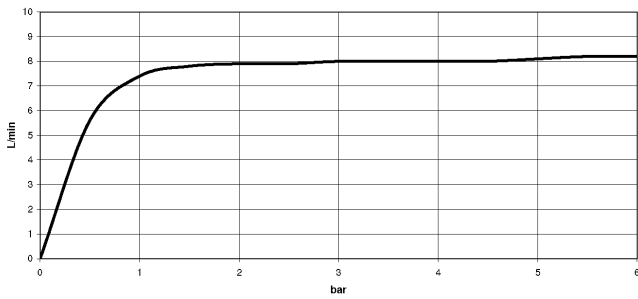

Codes & Standards

DIN 4109

ISO 3822

Ü-Zeichen



TARA ULTRA BAR TAP Single-lever mixer - Brushed Dark Platinum

TARA ULTRA

33 805 875

Certificates

LGA_18

33 805 875

Product version up to 5/15/2020

Product version from 5/15/2020 to 10/27/2020

Product version from 10/27/2020 to 5/3/2021

Product version from 5/3/2021

Parts for other finishes can be found here: [Chrome](#)

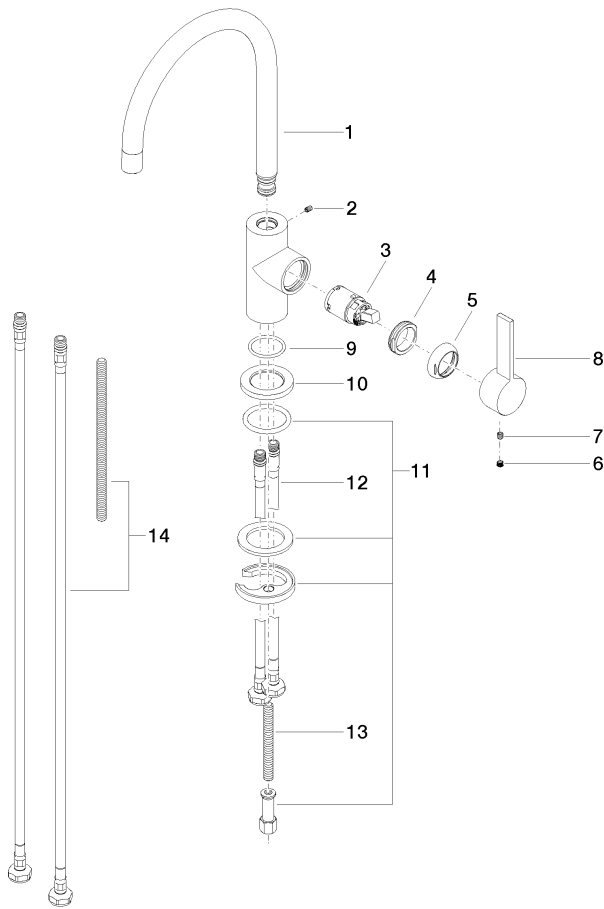



TARA ULTRA BAR TAP Single-lever mixer - Brushed Dark Platinum

TARA ULTRA

33 805 875

Spare parts list

Product version up to 5/15/2020

Product version from 5/15/2020 to 10/27/2020

Product version from 10/27/2020 to 5/3/2021

Product version from 5/3/2021

No.	Item Number	Name	Quantity used	Delivery time
	90 28 22 206 00-99	spout	15	30