







33 860 875



- 240mm projection
- pivotable 360°
- air-enriched flow and spray flow
- height of mixer 685 mm
- height up to aerator 129 mm
- hole diameter 35 mm
- sprayface with anti-scaling system
- max. flow 8 l/min at 3 bar flow pressure
- lead-free
- This product can help a building meet the requirements of Green Building Rating Systems, e.g. LEED®, BREEAM®, DGNB

Intrinsic protection against back flow.

	Brushed Dark Platinum	33 860 875-99
	Chrome	33 860 875-00
	Brushed Platinum	33 860 875-06
	Platinum	33 860 875-08
	Dark Chrome	33 860 875-19
	Brushed Chrome	33 860 875-93

Recommended miscellaneous

Strainer waste with control handle - Brushed Dark Platinum 10 712 970-99



Recommended miscellaneous

Dispenser without rosette - Brushed Dark Platinum 82 424 970-99



33 860 875

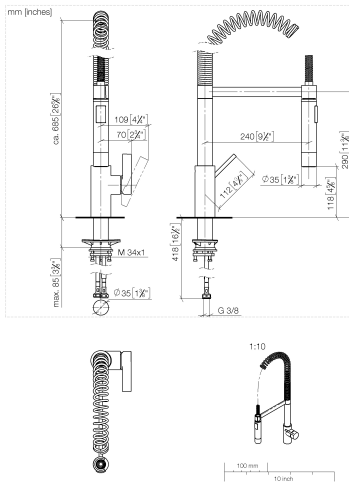

Flow rate chart

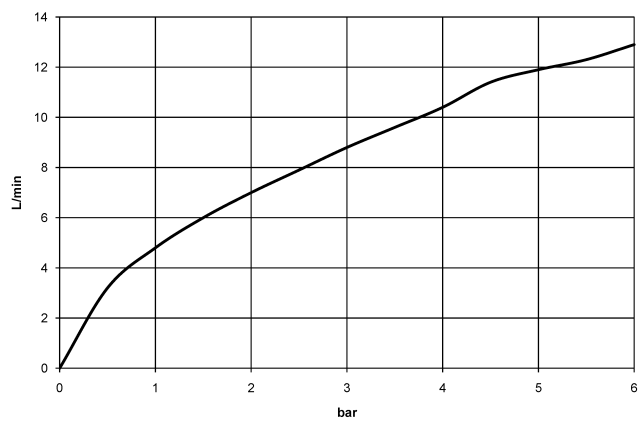

Codes & Standards

DIN 4109

EN 1717

ISO 3822

Ü-Zeichen



TARA ULTRA Profi single-lever mixer - Brushed Dark Platinum

TARA ULTRA

33 860 875

Certificates

LGA_18

Belgaqua_22_277_2

33 860 875

Parts for other finishes can be found here: [Chrome](#)

