











33 870 875



- 240mm projection
- pivatable spout 360°
- Optional swivel limiter available with swivel limiter set 12 823 970 90
- laminar and spray flow
- height of mixer 500 mm
- height up to laminar flow regulator 240 mm
- hole diameter 35 mm
- 1800 mm metal shower hose
- sprayface with anti-scaling system
- max. flow 10.4 l/min at 3 bar flow pressure
- lead-free
- This product can help a building meet the requirements of Green Building Rating Systems, e.g. LEED®, BREEAM®, DGNB

Intrinsic protection against back flow.

	Chrome	33 870 875-00
	Brushed Platinum	33 870 875-06
	Platinum	33 870 875-08
	Durabronze (23kt Gold)	33 870 875-09
	Dark Chrome	33 870 875-19
	Brushed Durabronze (23kt Gold)	33 870 875-28
	Matte Black	33 870 875-33
	Brushed Champagne (22kt Gold)	33 870 875-46
	Champagne (22kt Gold)	33 870 875-47
	Brushed Chrome	33 870 875-93
	Brushed Dark Platinum	33 870 875-99

Recommended miscellaneous

	Swivel limitation set -	12 823 970 90
---	--------------------------------	---------------

Recommended miscellaneous

	Strainer waste with control handle - Chrome	10 712 970-00
---	--	---------------

Recommended miscellaneous

	Dispenser without rosette - Chrome	82 424 970-00
---	---	---------------

33 870 875

mm [inches]

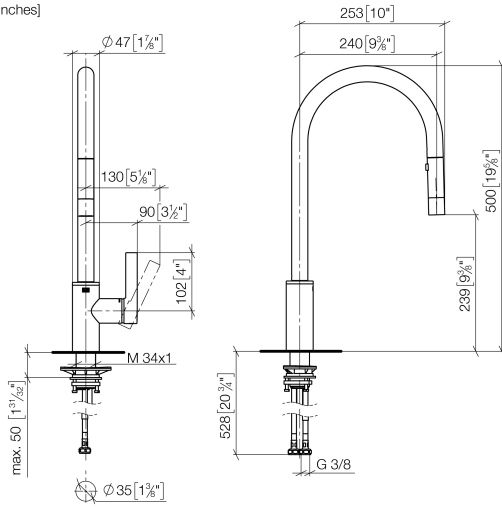

Flow rate chart



Certificates

Belgaqua_21-027- 27_3. LGA_28657. GDV_0400314.

33 870 875

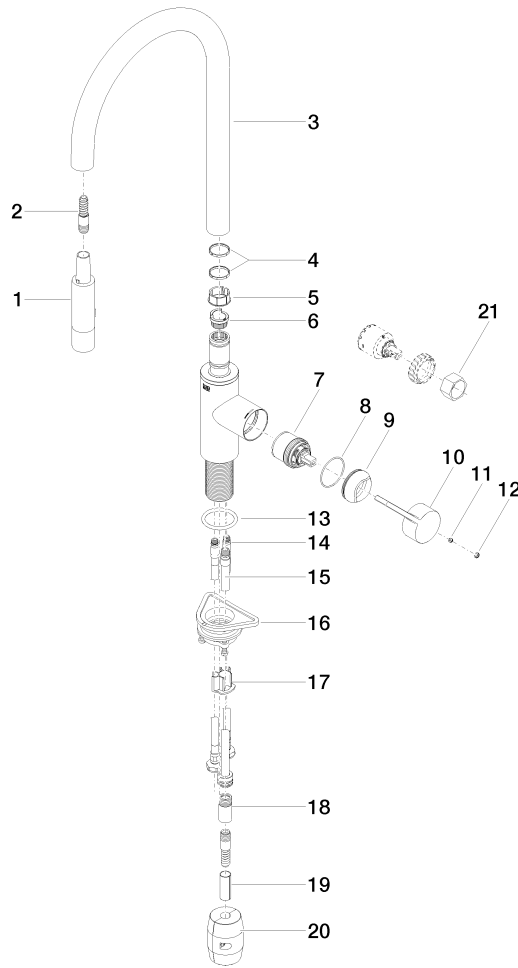

Spare parts list

No.	Item Number	Name	Quantity used	Delivery time
1	90 12 11 148 00-00	shower	1	10
2	04 30 02 120 00-00	hose	1	10
3	90 28 22 304 00-00	spout	1	10
4	09 28 10 160 90	ring	2	2
5	09 18 40 186 90	sleeve	1	2
6	09 30 11 203 90	ring	1	2
7	90 15 05 064 05 90	cartridge	1	2
8	09 14 10 190 90	seal	1	2
9	09 28 30 030-00	cover	1	10
10	09 20 87 020-00	handle	1	10
11	90 31 11 063 00 90	pin	1	2
12	90 31 20 087 00-00	plug	1	10
13	09 14 10 036 90	seal	1	2
14	04 30 04 101 00 90	hose	2	2
15	04 28 20 067 00 90	pipe	1	2
16	04 30 11 040 00 90	fixing set	1	2
17	09 20 93 056 90	insert	1	2
18	90 24 03 253 00 90	adaptor	1	2
19	09 30 03 038 90	hose	1	2
20	04 21 50 010 00 90	accessories	1	2
21	90 30 09 031 00 90	key	1	2