







33 880 888



- 200mm projection
- pivotable spout 360°
- air-enriched flow and spray flow
- height of mixer 415 mm
- test
- height up to aerator 275 mm
- hole diameter 35 mm
- sprayface with anti-scaling system
- max. flow 7 l/min at 3 bar flow pressure
- lead-free
- This product can help a building meet the requirements of Green Building Rating Systems, e.g. LEED®, BREEAM®, DGNB

Intrinsic protection against back flow.

	Dark Chrome	33 880 888-19
	Chrome	33 880 888-00
	Brushed Platinum	33 880 888-06
	Platinum	33 880 888-08
	Brushed Chrome	33 880 888-93
	Brushed Dark Platinum	33 880 888-99

Recommended miscellaneous

Dispenser with rosette - Dark Chrome 82 444 970-19



Recommended miscellaneous

Strainer waste with control handle - Dark Chrome 10 710 970-19



33 880 888

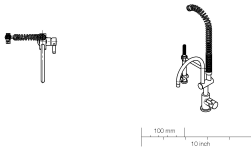
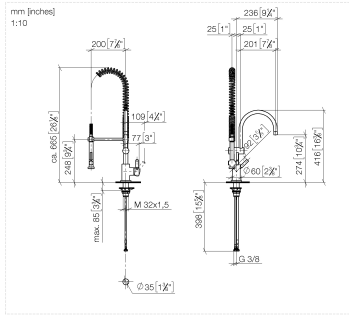

Flow rate chart

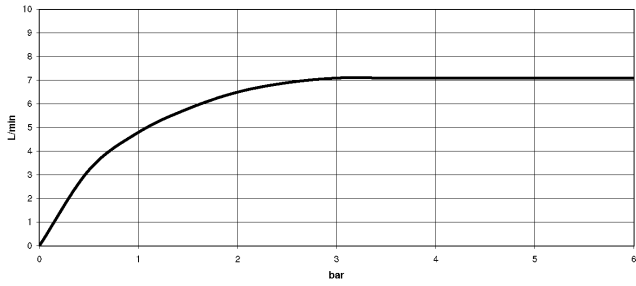

33 880 888

Parts for other
finishes can be found
here: [Chrome](#)

