

**TARA Shower pipe with shower thermostat without hand shower FlowReduce  
220 mm - Chrome**

TARA

34 458 892





- shower with fixed riser projection 452mm
- Rain shower: PURE RAIN, max. flow rate 7 l/min (at 3 bar)
- Function from: 6 l/min
- rain shower Ø 220 mm
- rain shower with anti-scale system
- rotary diverter with volume control and shut-off function
- slide-on rosettes Ø 70 mm
- height of fittings up to rain shower (bottom edge) 964mm
- height of fittings up to top edge of elbow 1267mm
- gauge 150 mm - 13 mm
- metal shower hose 1750mm with integrated anti-twist protection
- 1/2" connection
- slide bar
- Pipe diameter 23.5 mm
- This product can help a building meet the requirements of Green Building Rating Systems, e.g. LEED®, BREEAM®, DGNB

**This article does not include a hand shower!**

**Intrinsic protection against back flow.**

This article does not include a hand shower!

Intrinsic protection against back flow.

|                                                                                    |                               |               |
|------------------------------------------------------------------------------------|-------------------------------|---------------|
|   | Chrome                        | 34 458 892-00 |
|   | Brushed Platinum              | 34 458 892-06 |
|   | Platinum                      | 34 458 892-08 |
|   | Dark Chrome                   | 34 458 892-19 |
|   | Brushed Durabross (23kt Gold) | 34 458 892-28 |
|   | Matte Black                   | 34 458 892-33 |
|   | Brushed Champagne (22kt Gold) | 34 458 892-46 |
|   | Champagne (22kt Gold)         | 34 458 892-47 |
|   | Brushed Chrome                | 34 458 892-93 |
|  | Brushed Dark Platinum         | 34 458 892-99 |

Required miscellaneous

|                                                                                     |                                        |                       |
|-------------------------------------------------------------------------------------|----------------------------------------|-----------------------|
|  | <b>Hand shower FlowReduce - Chrome</b> | 28 016 979-00<br>0010 |
|-------------------------------------------------------------------------------------|----------------------------------------|-----------------------|

Required miscellaneous

|                                                                                     |                                        |                       |
|-------------------------------------------------------------------------------------|----------------------------------------|-----------------------|
|  | <b>Hand shower FlowReduce - Chrome</b> | 28 016 979-00<br>0010 |
|-------------------------------------------------------------------------------------|----------------------------------------|-----------------------|

Required miscellaneous

|                                                                                     |                                        |                       |
|-------------------------------------------------------------------------------------|----------------------------------------|-----------------------|
|  | <b>Hand shower FlowReduce - Chrome</b> | 28 012 979-00<br>0010 |
|-------------------------------------------------------------------------------------|----------------------------------------|-----------------------|

Required miscellaneous

|                                                                                     |                             |               |
|-------------------------------------------------------------------------------------|-----------------------------|---------------|
|  | <b>Hand shower - Chrome</b> | 28 017 979-00 |
|-------------------------------------------------------------------------------------|-----------------------------|---------------|

Required miscellaneous

|                                                                                     |                             |               |
|-------------------------------------------------------------------------------------|-----------------------------|---------------|
|  | <b>Hand shower - Chrome</b> | 28 016 979-00 |
|-------------------------------------------------------------------------------------|-----------------------------|---------------|

Required miscellaneous

|                                                                                     |                             |               |
|-------------------------------------------------------------------------------------|-----------------------------|---------------|
|  | <b>Hand shower - Chrome</b> | 28 016 979-00 |
|-------------------------------------------------------------------------------------|-----------------------------|---------------|

Required miscellaneous

|                                                                                     |                             |               |
|-------------------------------------------------------------------------------------|-----------------------------|---------------|
|  | <b>Hand shower - Chrome</b> | 28 012 979-00 |
|-------------------------------------------------------------------------------------|-----------------------------|---------------|

Required miscellaneous

|                                                                                     |                             |               |
|-------------------------------------------------------------------------------------|-----------------------------|---------------|
|  | <b>Hand shower - Chrome</b> | 28 018 979-00 |
|-------------------------------------------------------------------------------------|-----------------------------|---------------|

Required miscellaneous

|                                                                                     |                                        |                       |
|-------------------------------------------------------------------------------------|----------------------------------------|-----------------------|
|  | <b>Hand shower FlowReduce - Chrome</b> | 28 018 979-00<br>0010 |
|-------------------------------------------------------------------------------------|----------------------------------------|-----------------------|

**TARA Shower pipe with shower thermostat without hand shower FlowReduce  
220 mm - Chrome**

TARA

34 458 892

mm [inches]

1:10

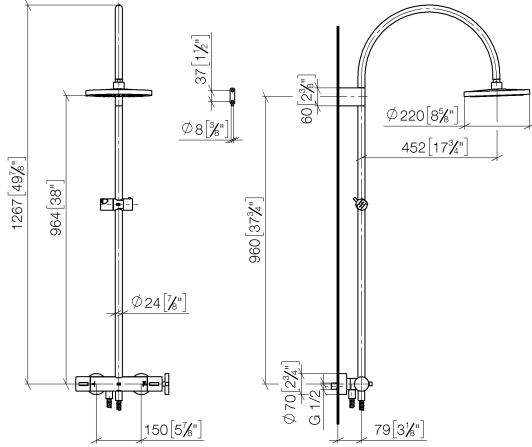

**Flow rate chart**

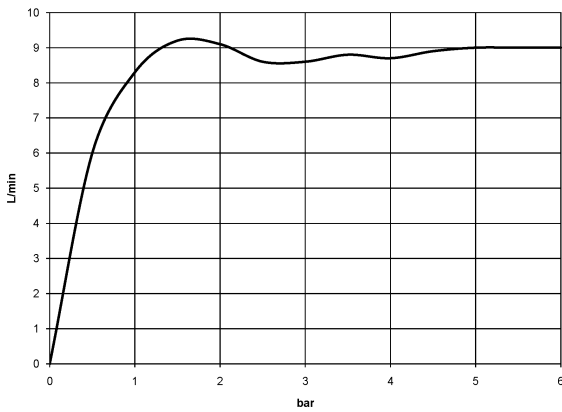

**Certificates**

Belgaqua\_22\_283\_2 WRAS\_2204013. LGA\_38737.  
7\_8.

34 458 892

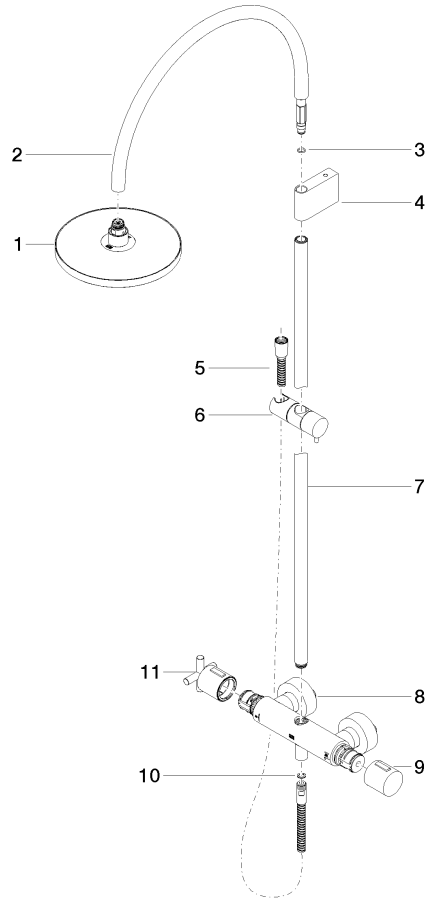

### Spare parts list

| No. | Item Number        | Name                                             | Quantity used | Delivery time |
|-----|--------------------|--------------------------------------------------|---------------|---------------|
| 1   | 90 12 05 092 20-00 | shower                                           | 1             | 10            |
| 2   | 04 28 22 346 00-00 | pipe                                             | 1             | 10            |
| 3   | 09 14 10 008 90    | seal                                             | 1             | 2             |
| 4   | 90 17 11 150 00-00 | holder                                           | 1             | 10            |
| 5   | 28 322 970-00      | Metal shower hose 1/2" x 3/8" x 1750 mm - Chrome | 1             | 2             |
| 6   | 12 570 970-00      | Slide unit - Chrome                              | 1             | 10            |
| 7   | 90 28 22 349 00-00 | pipe                                             | 1             | 10            |
| 8   | 04 17 01 250 00-00 | connection                                       | 1             | 10            |
| 9   | 90 17 33 015 00-00 | handle                                           | 1             | 10            |
| 10  | 90 14 20 026 00 90 | seal                                             | 1             | 2             |
| 11  | 90 17 33 021 00-00 | handle                                           | 1             | 10            |