







36 060 845

- cover plate 78 x 78 mm



	Brushed Chrome	36 060 845-93
	Chrome	36 060 845-00
	Brushed Platinum	36 060 845-06
	Dark Chrome	36 060 845-19
	Matte Black	36 060 845-33
	Brushed Dark Platinum	36 060 845-99

**Required miscellaneous**



**Concealed wall-mounted single-lever mixer -** 35 860 970 90

- max. recess depth 95 mm
- min. recess depth 80 mm



## LISSÉ Concealed single-lever mixer with cover plate - Brushed Chrome

---

LISSÉ

36 060 845

### Certificates

---

LGA\_29905.

36 060 845

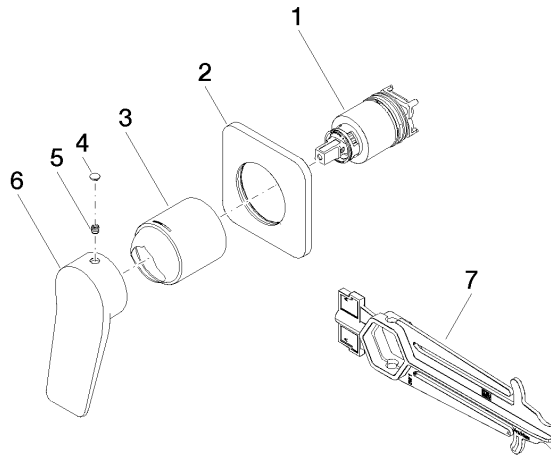

### Spare parts list

No.	Item Number	Name	Quantity used	Delivery time
1	90 15 05 046 02 90	cartridge	1	2
2	90 27 84 020 00-93	rosette	1	20
3	09 11 02 288-93	cover	1	20
4	90 31 20 087 00-93	plug	1	20
5	90 31 11 030 00 90	pin	1	2
6	09 20 84 021-93	handle	1	20
7	90 30 09 064 00 90	key	1	2