

Concealed single-lever mixer with integrated shower connection with shower set without hand shower - Brushed Light Gold

IMO

36 111 970















- metal shower hose 1750mm with integrated anti-twist protection
- slide bar
- Pipe diameter 18 mm
- WRAS 2011027

This article does not include a hand shower!
Intrinsic protection against back flow.

This article does not include a hand shower!

Intrinsic protection against back flow.

Fits: IMO, LULU, MADISON, MEM, TARA, CL.1, LISSÉ, VAIA, META, CYO

| | | |
|--|--------------------------------|---------------|
|  | Brushed Light Gold | 36 111 970-27 |
|  | Chrome | 36 111 970-00 |
|  | Brushed Platinum | 36 111 970-06 |
|  | Platinum | 36 111 970-08 |
|  | Dark Chrome | 36 111 970-19 |
|  | Brushed Durabronze (23kt Gold) | 36 111 970-28 |
|  | Matte Black | 36 111 970-33 |
|  | Brushed Bronze | 36 111 970-42 |
|  | Brushed Champagne (22kt Gold) | 36 111 970-46 |
|  | Champagne (22kt Gold) | 36 111 970-47 |
|  | Brushed Chrome | 36 111 970-93 |
|  | Brushed Dark Platinum | 36 111 970-99 |

Required miscellaneous



- Concealed wall mounting -**
- min. recess depth 80 mm
 - max. recess depth 105 mm

35 050 970 90

Required miscellaneous



- Hand shower FlowReduce -
Brushed Light Gold**

28 018 979-27
0010

Concealed single-lever mixer with integrated shower connection with shower set without hand shower - Brushed Light Gold

IMO

36 111 970
mm [inches]

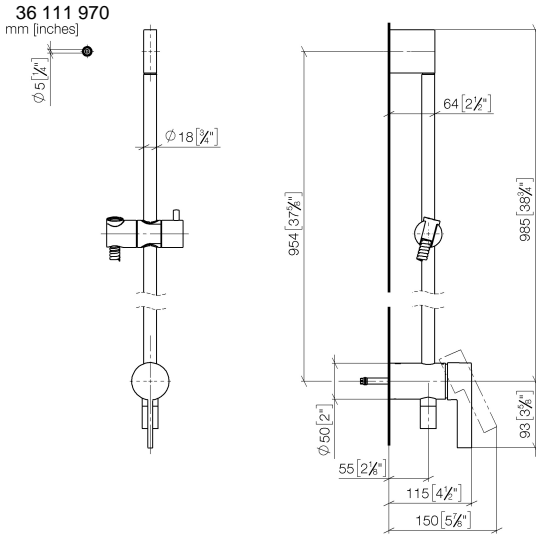

Concealed single-lever mixer with integrated shower connection with shower set without hand shower - Brushed Light Gold

IMO

36 111 970

Product version from 10/1/2023

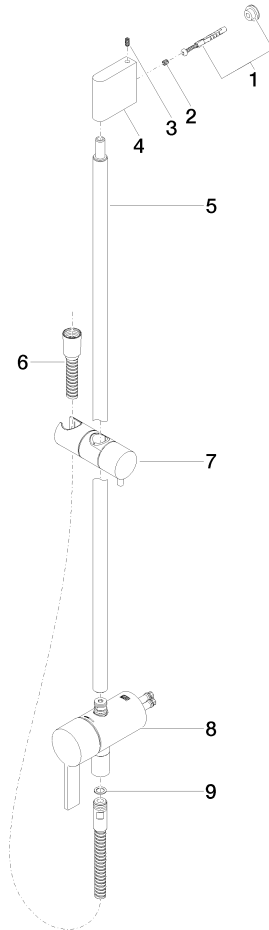



Concealed single-lever mixer with integrated shower connection with shower set without hand shower - Brushed Light Gold

IMO

36 111 970

Spare parts list

Product version from 10/1/2023

| No. | Item Number | Name | Quantity used | Delivery time |
|-----|--------------------|------------|---------------|---------------|
| | 05 17 20 726 02 90 | fixing set | 11 | 2 |