







**SYMETRICS Concealed three-way diverter - Chrome**

IMO

36 210 980



- rotary diverter
- rosette 60 x 60 mm
- WRAS 2307045

	Chrome	36 210 980-00
	Brushed Platinum	36 210 980-06
	Brushed Light Gold	36 210 980-27
	Brushed Durabronze (23kt Gold)	36 210 980-28
	Brushed Champagne (22kt Gold)	36 210 980-46
	Champagne (22kt Gold)	36 210 980-47
	Brushed Dark Platinum	36 210 980-99

**Required miscellaneous**



- Concealed three-way diverter -** 35 203 970 90
- max. recess depth 160 mm
  - min. recess depth 85 mm

36 210 980

mm [inches]

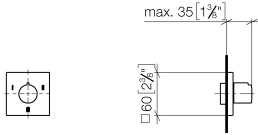

**Flow rate chart**

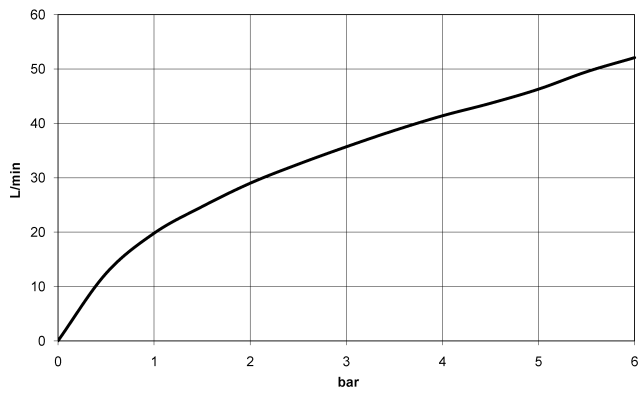

**Codes & Standards**

DIN 4109

ISO 3822

Scottish Water  
Byelaws

UK Water Supply  
Regulations

**Ü-Zeichen**



## SYMETRICS Concealed three-way diverter - Chrome

---

IMO

36 210 980

### Certificates

---

WRAS\_2307

LGA\_38

36 210 980

Product version from 4/1/2022

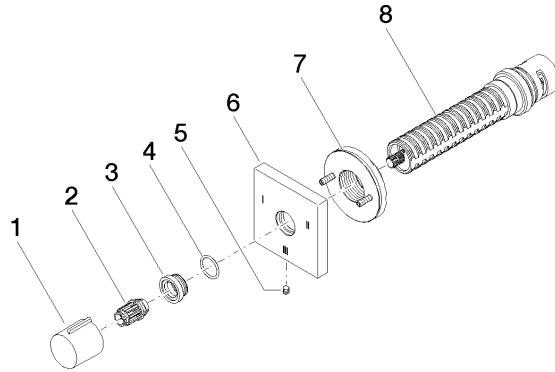



# SYMETRICS Concealed three-way diverter - Chrome

IMO

36 210 980

## Spare parts list

### Product version from 4/1/2022

No.	Item Number	Name	Quantity used	Delivery time
	09 20 98 001-00	handle	8	10