









36 607 819



- rosette Ø 60 mm
- head part with cut-to-length spindle and sleeve
- WRAS 2011026, 2010066

|  |                                |               |
|--|--------------------------------|---------------|
|   | Champagne (22kt Gold)          | 36 607 819-47 |
|   | Chrome                         | 36 607 819-00 |
|   | Brushed Platinum               | 36 607 819-06 |
|   | Platinum                       | 36 607 819-08 |
|   | Dark Chrome                    | 36 607 819-19 |
|   | Brushed Durabronze (23kt Gold) | 36 607 819-28 |
|   | Brushed Bronze                 | 36 607 819-42 |
|   | Brushed Champagne (22kt Gold)  | 36 607 819-46 |
|  | Brushed Dark Platinum          | 36 607 819-99 |

Required miscellaneous

- Wall valve 1/2" -** 35 607 970 90
- max. recess depth 145 mm
  - min. recess depth 75 mm



36 607 819

mm [inches]

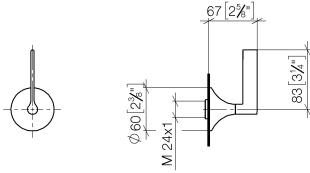

Certificates

DVGW\_DW-  
6501DN0116.

WRAS\_2011026.

LGA\_29931.

WRAS\_2010066.

DVGW\_DW-  
6512DN0706.

36 607 819

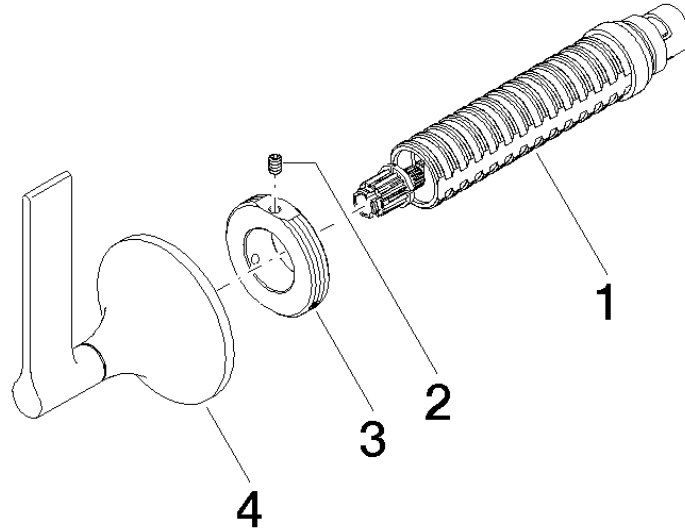

### Spare parts list

| No. | Item Number        | Name   | Quantity used | Delivery time |
|-----|--------------------|--------|---------------|---------------|
| 1   | 90 90 03 143 00 90 | top    | 1             | 2             |
| 2   | 09 31 11 008 90    | pin    | 1             | 2             |
| 3   | 09 21 02 163 90    | disc   | 1             | 2             |
| 4   | 90 20 80 015 00-47 | handle | 1             | 30            |