









36 607 980



- rosette 60 x 60 mm
- head part with cut-to-length spindle and sleeve
- WRAS 2011026, 2010066

	Brushed Light Gold	36 607 980-27
	Chrome	36 607 980-00
	Brushed Platinum	36 607 980-06
	Platinum	36 607 980-08
	Dark Chrome	36 607 980-19
	Brushed Durabronze (23kt Gold)	36 607 980-28
	Matte Black	36 607 980-33
	Brushed Chrome	36 607 980-93
	Brushed Dark Platinum	36 607 980-99

36 607 980

mm [inches]

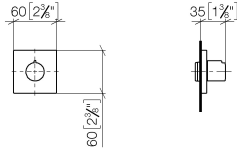

Certificates

WRAS\_2011026.

LGA\_29931.

WRAS\_2010066.

DVGW\_DW-  
6512DN0706.

36 607 980

Parts for other finishes can be found here: [Chrome](#)

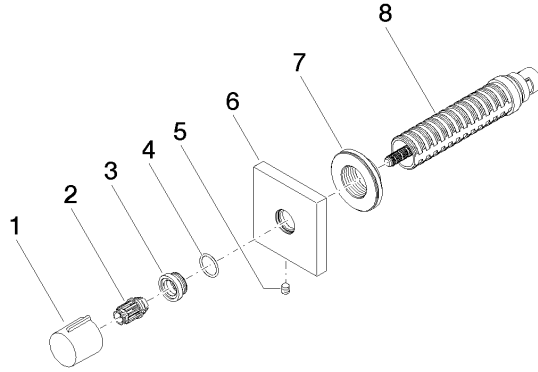

### Spare parts list

No.	Item Number	Name	Quantity used	Delivery time
1	09 20 98 001-27	handle	1	60
2	09 12 12 005 90	fixing cap	1	2
3	09 12 12 043-27	base	1	60
4	09 14 10 017 90	seal	1	2
5	90 31 11 004 00 90	pin	1	2
6	09 27 98 014-27	rosette	1	60
7	09 21 02 151 90	sleeve	1	2
8	90 90 03 202 00 90	top	1	2