

CYO Wall-mounted basin mixer without pop-up waste - Platinum / Brushed Platinum

CYO







36 707 811



- 160mm projection
- fixed spout
- rectangular, air-enriched flow
- hole diameter valve 37 mm
- hole diameter spout 37 mm
- handle Ø 60mm
- max. flow 4.5 l/min
- lead-free
- This product can help a building meet the requirements of Green Building Rating Systems, e.g. LEED®, BREEAM®, DGNB
- WRAS

NOTE: The handle inserts must be ordered separately from the fittings!

NOTE: The handle inserts must be ordered separately from the fittings!

	Platinum / Brushed Platinum	36 707 811-36
	Chrome	36 707 811-00
	Brushed Platinum	36 707 811-06
	Dark Chrome	36 707 811-19
	Brushed Durabronze (23kt Gold)	36 707 811-28
	Durabronze / Brushed Durabronze (23kt Gold)	36 707 811-38
	Brushed Dark Platinum	36 707 811-99

Required miscellaneous



- Concealed wall-mounted mixer centred spout -** 35 700 970 90
- max. recess depth mm
 - min. recess depth mm

Required miscellaneous



- Concealed wall-mounted mixer variable positioning -** 35 720 970 90
- min. recess depth mm
 - max. recess depth mm

36 707 811
mm [inches]

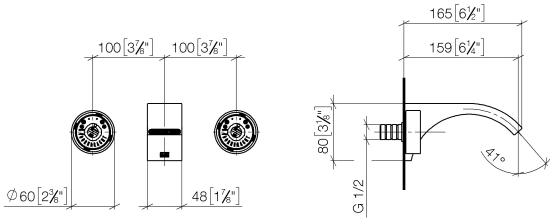

Flow rate chart

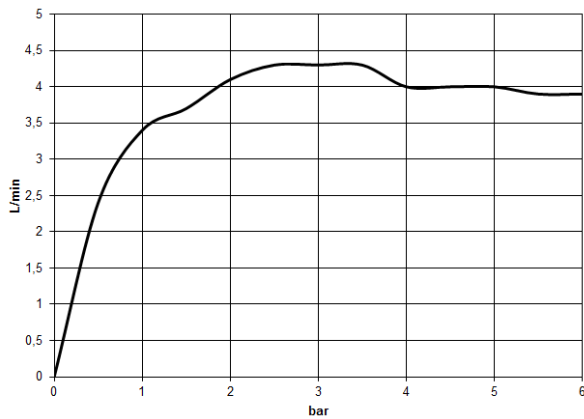

Codes & Standards

DIN 4109

ISO 3822

NSF372

NSF61

Scottish Water
Byelaws

UK Water Supply
Regulations

Ü-Zeichen



CYO Wall-mounted basin mixer without pop-up waste - Platinum / Brushed
Platinum

CYO

36 707 811

Certificates

WRAS_2111

IAPMO_N-4976

IAPMO_6397

LGA_38

36 707 811

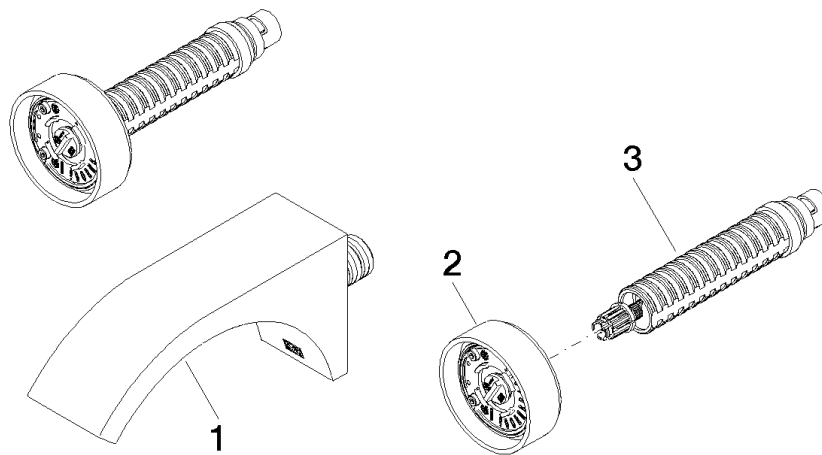

Spare parts list

No.	Item Number	Name	Quantity used	Delivery time
1	13 800 811-36	CYO Wall-mounted basin spout without pop-up waste - Platinum / Brushed Platinum	1	20
2	90 18 40 290 00-36	handle	1	20
3	90 90 03 171 01 90	top	1	2