











META Wall-mounted single-lever basin mixer without pop-up waste - Brushed Champagne (22kt Gold)

META

36 860 660



- 190mm projection
- fixed spout
- circular, air-enriched flow
- hole diameter spout 37 mm
- hole diameter single-lever mixer 57 mm
- rosette for spout Ø 55mm
- rosette for mixer Ø 78mm
- max. flow 5.7 l/min
- lead-free
- This product can help a building meet the requirements of Green Building Rating Systems, e.g. LEED®, BREEAM®, DGNB

| | | |
|---|-------------------------------|---------------|
|  | Brushed Champagne (22kt Gold) | 36 860 660-46 |
|  | Chrome | 36 860 660-00 |
|  | Brushed Platinum | 36 860 660-06 |
|  | Dark Chrome | 36 860 660-19 |
|  | Light Gold | 36 860 660-26 |
|  | Brushed Light Gold | 36 860 660-27 |
|  | Matte Black | 36 860 660-33 |
|  | Brushed Bronze | 36 860 660-42 |
|  | Champagne (22kt Gold) | 36 860 660-47 |
|  | Brushed Chrome | 36 860 660-93 |
|  | Brushed Dark Platinum | 36 860 660-99 |

Required miscellaneous



Concealed wall-mounted single-lever mixer mixer on right - 35 816 970 90
 •NOTE:Not suitable for concealed installation.Connection by means of angle valves, mounted with screws to back wall.

Required miscellaneous



Concealed wall-mounted single-lever mixer - 35 860 970 90
 •min. recess depth 80 mm
 •max. recess depth 95 mm

36 860 660
mm [inches]

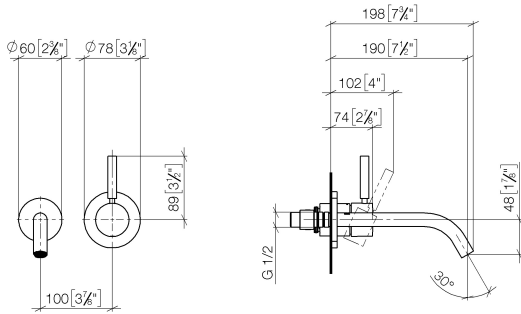

Flow rate chart



Trajectory diagram

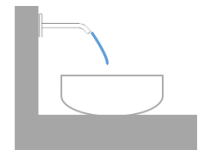

Certificates

DVGW_DW-
6512DN0435.

WRAS_2107018.

36 860 660

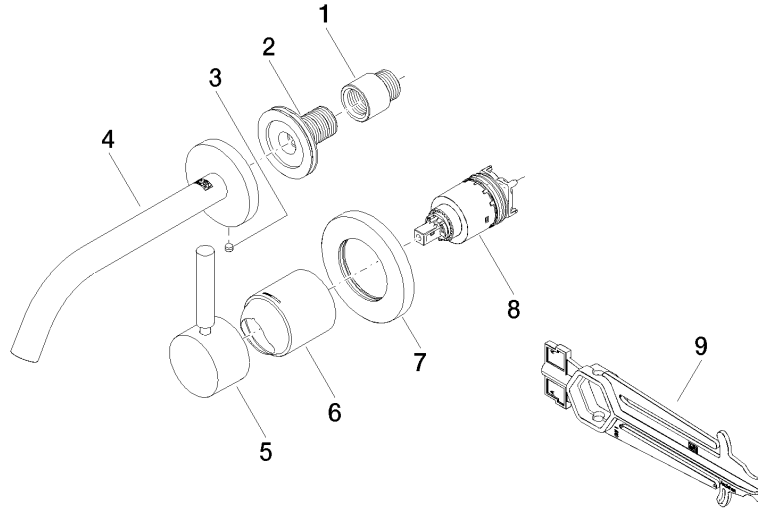

Spare parts list

| No. | Item Number | Name | Quantity used | Delivery time |
|-----|--------------------|-----------|---------------|---------------|
| 1 | 09 24 03 072 10 90 | nipple | 1 | 2 |
| 2 | 90 24 03 280 00 90 | nipple | 1 | 2 |
| 3 | 09 31 11 112 90 | pin | 1 | 60 |
| 4 | 90 28 22 323 00-46 | spout | 1 | 30 |
| 5 | 90 20 66 007 00-46 | handle | 1 | 30 |
| 6 | 09 11 02 288-46 | cover | 1 | 60 |
| 7 | 90 27 62 011 00-46 | rosette | 1 | 30 |
| 8 | 90 15 05 064 01 90 | cartridge | 1 | 2 |
| 9 | 90 30 09 064 00 90 | key | 1 | 2 |