





**SERIES-VARIOUS AQUAHALO Rain panel - Champagne (22kt Gold)**

41 750 979



- exposed trim parts
- Rain panel with 3 different flow modes
- AQUACIRCLE RAIN: Circular rain curtain, max. flow rate 14 l/min (at 3 bar)
- TEMPEST RAIN: Natural rain, max. flow rate 9 l/min (at 3 bar)
- DIAMOND RAIN: Ring of rain, max. flow rate 6.8 l/min (at 3 bar)
- Outer diameter: 605 mm, opening diameter: 465 mm
- Weight: 6 kg
- central LED Spot 3000 K
- Protection rating IP67
- Recommended control element: xTool
- Not suitable for use in a steam room.

	Champagne (22kt Gold)	41 750 979-47
	Chrome	41 750 979-00
	Brushed Platinum	41 750 979-06
	Matte Black	41 750 979-33
	Brushed Champagne (22kt Gold)	41 750 979-46

**Required miscellaneous**



- SERIES-VARIOUS AQUAHALO** 35 750 970-47  
**Concealed ceiling installation box - Champagne (22kt Gold)**
- concealed rough parts
  - Ceiling installation enclosure 605 x 605 x 95 mm
  - Weight: 10 kg
  - min. recess depth 110 mm

SERIES-VARIOUS AQUAHALO Rain panel - Champagne (22kt Gold)

41 750 979

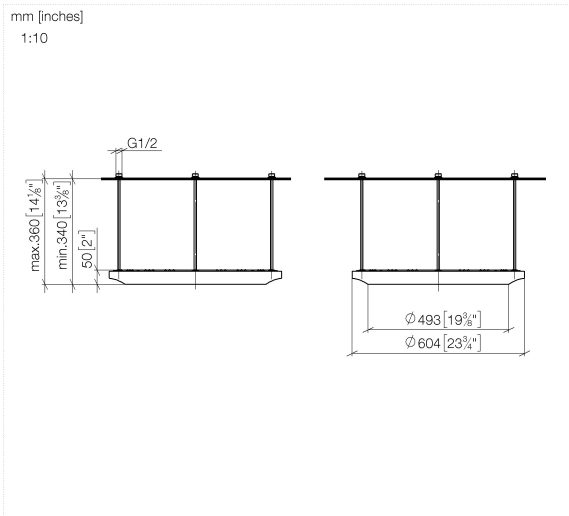

## SERIES-VARIOUS AQUAHALO Rain panel - Champagne (22kt Gold)

41 750 979

Parts for other finishes can be found here: [Chrome](#)

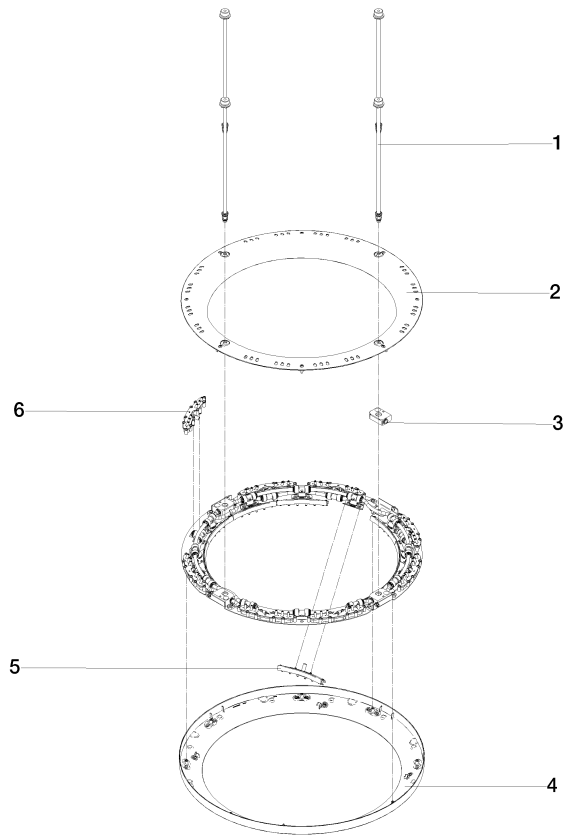

### Spare parts list

No.	Item Number	Name	Quantity used	Delivery time
1	90 28 22 605 01-47	distributor	1	-
Spare part can no longer be ordered, please order the replacement item				
2	90 12 05 087 00-47	casing	1	-
Spare part can no longer be ordered, please order the replacement item				
3	90 24 03 535 00 90	distributor	1	10
4	90 12 05 088 00-47	casing	1	-
Spare part can no longer be ordered, please order the replacement item				
5	90 17 09 060 01 90	jet module	1	2
6	90 17 09 061 01 90	jet module TEMPEST	8	2