







ST 010 108 5811



- 133mm projection
- fixed spout
- rectangular, air-enriched flow
- height of mixer 180 mm
- height up to aerator 128 mm
- hole diameter spout 35 mm
- hole diameter valve 32 mm
- handle Ø 60mm
- 2x screw-in M 8 x 1 pressure hose, leak-tested
- 1x screw-in M 10 x 1 pressure hose, leak-tested
- max. flow 4.5 l/min
- progressive cartridge
- lead-free
- with hot / cold marking
- This product can help a building meet the requirements of Green Building Rating Systems, e.g. LEED®, BREEAM®, DGNB

| | | |
|--|---|--------------------|
|  | Brushed Platinum | ST 010 108 5811-06 |
|  | Chrome | ST 010 108 5811-00 |
|  | Dark Chrome | ST 010 108 5811-19 |
|  | Brushed Durabronze (23kt Gold) | ST 010 108 5811-28 |
|  | Platinum / Brushed Platinum | ST 010 108 5811-36 |
|  | Durabronze / Brushed Durabronze (23kt Gold) | ST 010 108 5811-38 |
|  | Brushed Dark Platinum | ST 010 108 5811-99 |

Individual components of this set

You need the following components for this set

1x 29 217 811-06



1x 11 188 811-06





CYO Two-hole basin mixer without pop-up waste - Brushed Platinum

CYO







ST 010 108 5811

ST 010 108 5811



- 133mm projection
- fixed spout
- rectangular, air-enriched flow
- height of mixer 180 mm
- height up to aerator 128 mm
- hole diameter spout 35 mm
- hole diameter valve 32 mm
- handle Ø 60mm
- 2x screw-in M 8 x 1 pressure hose, leak-tested
- 1x screw-in M 10 x 1 pressure hose, leak-tested
- max. flow 4.5 l/min
- progressive cartridge
- lead-free
- This product can help a building meet the requirements of Green Building Rating Systems, e.g. LEED®, BREEAM®, DGNB
- WRAS 2201012

NOTE: The handle inserts must be ordered separately from the fittings!

| | | |
|--|---|---------------|
|  | Brushed Platinum | 29 217 811-06 |
|  | Chrome | 29 217 811-00 |
|  | Dark Chrome | 29 217 811-19 |
|  | Brushed Durabress (23kt Gold) | 29 217 811-28 |
|  | Platinum / Brushed Platinum | 29 217 811-36 |
|  | Durabress / Brushed Durabress (23kt Gold) | 29 217 811-38 |
|  | Brushed Dark Platinum | 29 217 811-99 |

ST 010 108 5811

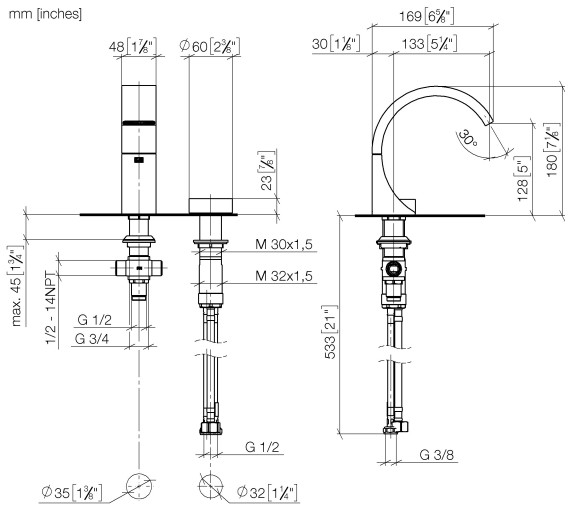

Flow rate chart

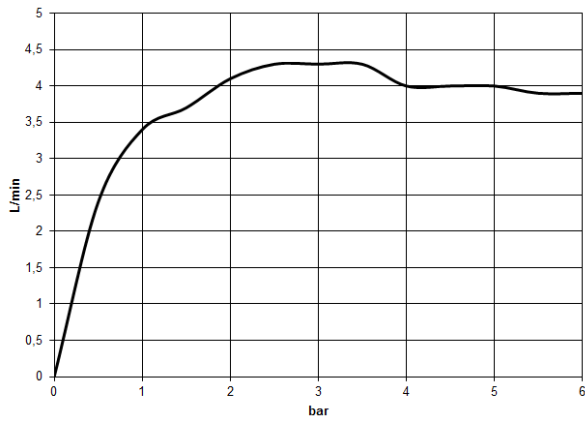

Certificates

WRAS_2201012. LGA_38103.

ST 010 108 5811

Parts for other finishes can be found here: [Chrome](#)

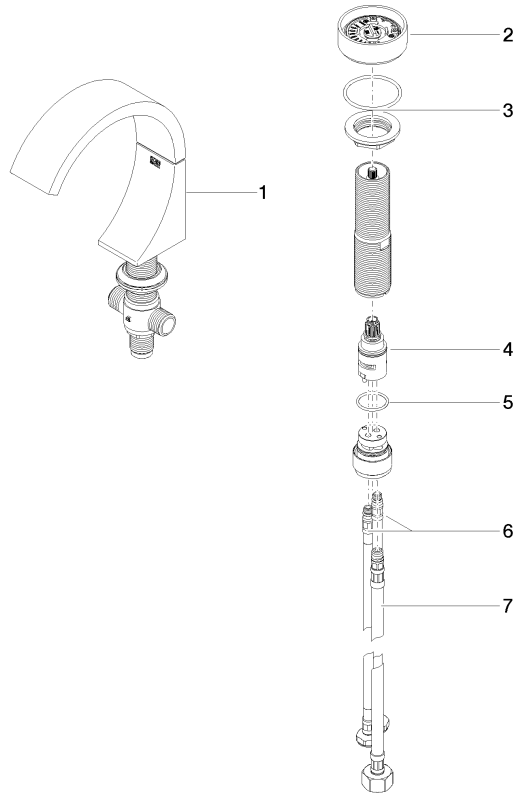







Spare parts list

| No. | Item Number | Name | Quantity used | Delivery time |
|-----|--------------------|--|---------------|---------------|
| 1 | 13 715 811-06 | CYO Deck-mounted basin spout without pop-up waste - Brushed Platinum | 1 | 10 |
| 2 | 90 18 40 290 00-06 | handle | 1 | 10 |
| 3 | 04 30 11 038 67 90 | fixing set | 1 | 2 |
| 4 | 90 90 03 169 00 90 | top | 1 | 2 |
| 5 | 09 14 10 112 90 | seal | 1 | 2 |
| 6 | 04 30 04 100 00 90 | hose | 2 | 2 |
| 7 | 04 30 04 019 00 90 | hose | 1 | 2 |

ST 010 108 5811

- with hot / cold marking
- for two-hole basin mixer



| | | |
|--|-------------------------------|---------------|
|  | Brushed Platinum | 11 188 811-06 |
|  | Chrome | 11 188 811-00 |
|  | Platinum | 11 188 811-08 |
|  | Durabress (23kt Gold) | 11 188 811-09 |
|  | Dark Chrome | 11 188 811-19 |
|  | Brushed Durabress (23kt Gold) | 11 188 811-28 |
|  | Brushed Dark Platinum | 11 188 811-99 |



CYO Two-hole basin mixer without pop-up waste - Brushed Platinum

CYO

ST 010 108 5811

ST 010 108 5811

mm [inches]

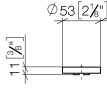



CYO Two-hole basin mixer without pop-up waste - Brushed Platinum

CYO

ST 010 108 5811

ST 010 108 5811

Parts for other
finishes can be found
here: [Chrome](#)

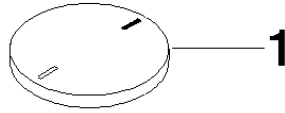



CYO Two-hole basin mixer without pop-up waste - Brushed Platinum

CYO

ST 010 108 5811