







**CYO Two-hole basin mixer without pop-up waste - Brushed Durabron (23kt Gold)**

CYO

ST 010 108 7811



- 167mm projection
- fixed spout
- rectangular, air-enriched flow
- height of mixer 198 mm
- height up to aerator 133 mm
- hole diameter spout 35 mm
- hole diameter valve 32 mm
- handle Ø 60mm
- 2x screw-in M 8 x 1 pressure hose, leak-tested
- 1x screw-in M 10 x 1 pressure hose, leak-tested
- max. flow 4.5 l/min
- progressive cartridge
- lead-free
- with hot / cold marking
- This product can help a building meet the requirements of Green Building Rating Systems, e.g. LEED®, BREEAM®, DGNB

	Brushed Durabron (23kt Gold)	ST 010 108 7811-28
	Chrome	ST 010 108 7811-00
	Brushed Platinum	ST 010 108 7811-06
	Dark Chrome	ST 010 108 7811-19
	Platinum / Brushed Platinum	ST 010 108 7811-36
	Durabron / Brushed Durabron (23kt Gold)	ST 010 108 7811-38
	Brushed Dark Platinum	ST 010 108 7811-99

**Individual components of this set**

You need the following components for this set

1x 11 188 811-28



1x 29 218 811-28





CYO Two-hole basin mixer without pop-up waste - Brushed Durabronz (23kt Gold)

---

CYO

ST 010 108 7811







**CYO Two-hole basin mixer without pop-up waste - Brushed Durabron (23kt Gold)**

CYO

ST 010 108 7811

- with hot / cold marking
- for two-hole basin mixer



	Brushed Durabron (23kt Gold)	11 188 811-28
	Chrome	11 188 811-00
	Brushed Platinum	11 188 811-06
	Platinum	11 188 811-08
	Durabron (23kt Gold)	11 188 811-09
	Dark Chrome	11 188 811-19
	Brushed Dark Platinum	11 188 811-99

CYO Two-hole basin mixer without pop-up waste - Brushed Durabronz (23kt  
Gold)

CYO

ST 010 108 7811  
mm [inches]

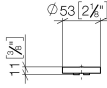



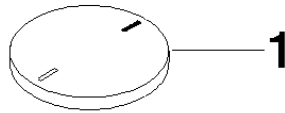



ST 010 108 7R11  
Parts for other finishes can be found here: Chrome



- 167mm projection
- fixed spout
- rectangular, air-enriched flow
- height of mixer 198 mm
- height up to aerator 133 mm
- hole diameter spout 35 mm
- hole diameter valve 32 mm
- handle Ø 60mm
- 2x screw-in M 8 x 1 pressure hose, leak-tested
- 1x screw-in M 10 x 1 pressure hose, leak-tested
- max. flow 4.5 l/min
- progressive cartridge
- lead-free
- This product can help a building meet the requirements of Green Building Rating Systems, e.g. LEED®, BREEAM®, DGNB
- WRAS 2201012

NOTE: The handle inserts must be ordered separately from the fittings!

	Brushed Durabron (23kt Gold)	29 218 811-28
	Chrome	29 218 811-00
	Brushed Platinum	29 218 811-06
	Dark Chrome	29 218 811-19
	Platinum / Brushed Platinum	29 218 811-36
	Durabron / Brushed Durabron (23kt Gold)	29 218 811-38
	Brushed Dark Platinum	29 218 811-99



CYO Two-hole basin mixer without pop-up waste - Brushed Durabronze (23kt Gold)

---

CYO

ST 010 108 7811



CYO Two-hole basin mixer without pop-up waste - Brushed Durabronz (23kt Gold)

---

CYO

ST 010 108 7811



CYO Two-hole basin mixer without pop-up waste - Brushed Durabronze (23kt Gold)

---

CYO

ST 010 108 7811



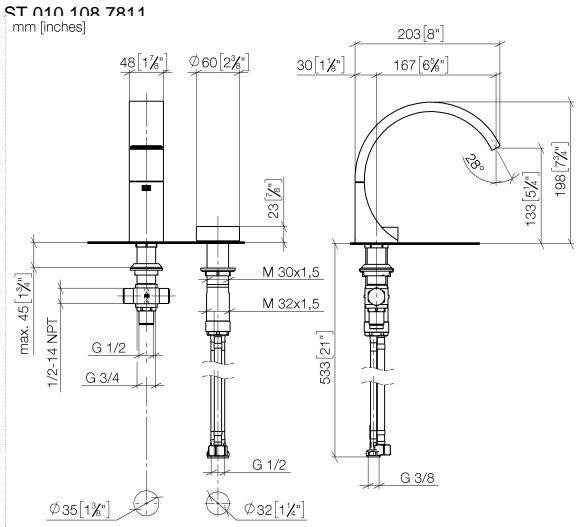

**Flow rate chart**

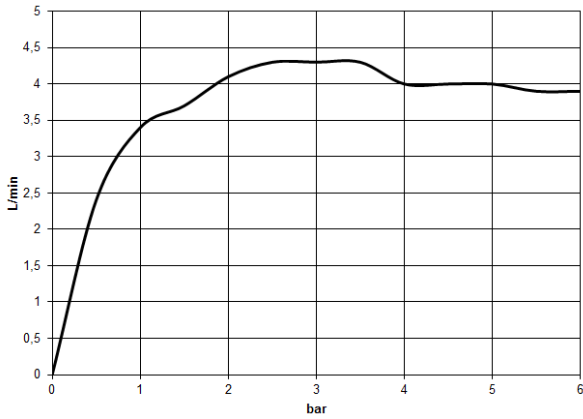

**Certificates**

WRAS\_2201012. LGA\_38103.

ST 010 108 7R11  
 Parts for other  
 finishes can be found  
 here: Chrome

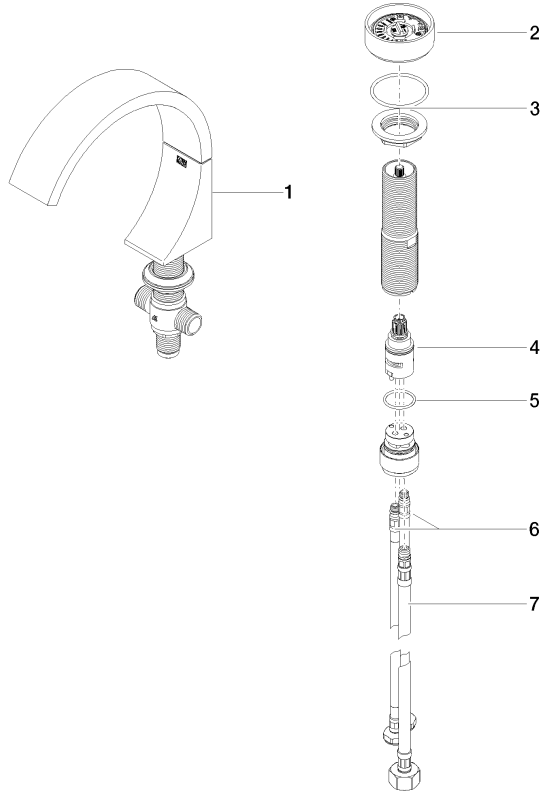

**Spare parts list**

No.	Item Number	Name	Quantity used	Delivery time
1	13 717 811-28	CYO Deck-mounted basin spout without pop-up waste - Brushed Durabronz (23kt Gold)	1	20
2	90 18 40 290 00-28	handle	1	20
3	04 30 11 038 67 90	fixing set	1	2
4	90 90 03 169 00 90	top	1	2
5	09 14 10 112 90	seal	1	2
6	04 30 04 100 00 90	hose	2	2
7	04 30 04 019 00 90	hose	1	2