

ST 050 201 8710



- slide bar
- Pipe diameter 18 mm
- Four settings: COMPACT RAIN, COMPACT SOFT FLOW, COMPACT AQUAPRESSURE FLOW, COMPACT CASCADE, max. flow rate 6.8 l/min (at 3 bar)
- rosette 78 x 55 mm
- gauge 800 mm
- metal shower hose 1750mm with integrated anti-twist protection
- shower hose connector 3/8"
- spray head Ø 120mm
- This product can help a building meet the requirements of Green Building Rating Systems, e.g. LEED®, BREEAM®, DGNB

|  |                                   |                         |
|--|-----------------------------------|-------------------------|
|    | Chrome                            | ST 050 201 8710-00 0010 |
|    | Chrome                            | ST 050 201 7710-00      |
|    | Brushed Platinum                  | ST 050 201 7710-06      |
|    | Brushed Platinum                  | ST 050 201 8710-06 0010 |
|    | Platinum                          | ST 050 201 7710-08      |
|    | Platinum                          | ST 050 201 8710-08 0010 |
|    | Brushed Durabronze<br>(23kt Gold) | ST 050 201 7710-28      |
|    | Brushed Durabronze<br>(23kt Gold) | ST 050 201 8710-28 0010 |
|    | Matte Black                       | ST 050 201 7710-33      |
|    | Matte Black                       | ST 050 201 8710-33 0010 |
|    | Brushed Dark<br>Platinum          | ST 050 201 7710-99      |
|  | Brushed Dark<br>Platinum          | ST 050 201 8710-99 0010 |

**Individual components of this set**

You need the following components for this set



1x 26 413 710-00



1x 28 012 979-00 0010



## LULU Shower set - Chrome

---

LULU







ST 050 201 8710

ST 050 201 8710



- slide bar
- rosette 78 x 55 mm
- gauge 800 mm
- metal shower hose 1750mm with integrated anti-twist protection
- shower hose connector 3/8"
- Pipe diameter 18 mm

This article does not include a hand shower!

|  |                                  |               |
|--|----------------------------------|---------------|
|  | Chrome                           | 26 413 710-00 |
|  | Brushed Platinum                 | 26 413 710-06 |
|  | Platinum                         | 26 413 710-08 |
|  | Brushed Durabronz<br>(23kt Gold) | 26 413 710-28 |
|  | Matte Black                      | 26 413 710-33 |
|  | Brushed Dark<br>Platinum         | 26 413 710-99 |

**Recommended miscellaneous**

|   |  |               |
|---|--|---------------|
|  | <b>Concealed wall elbow -</b><br>•max. recess depth 163 mm<br>•min. recess depth 90 mm | 35 085 970 90 |
|---|--|---------------|

**Required miscellaneous**

|   |  |                       |
|---|--|-----------------------|
|  | <b>Hand shower FlowReduce -<br/>Chrome</b> | 28 016 979-00<br>0010 |
|---|--|-----------------------|

**Required miscellaneous**

|   |                             |               |
|---|-----------------------------|---------------|
|  | <b>Hand shower - Chrome</b> | 28 017 979-00 |
|---|-----------------------------|---------------|

**Required miscellaneous**

|   |                             |               |
|---|-----------------------------|---------------|
|  | <b>Hand shower - Chrome</b> | 28 012 979-00 |
|---|-----------------------------|---------------|

**Required miscellaneous**

|   |  |                       |
|---|--|-----------------------|
|  | <b>Hand shower FlowReduce -<br/>Chrome</b> | 28 018 979-00<br>0010 |
|---|--|-----------------------|

**Recommended miscellaneous**

|   |                                 |               |
|---|---------------------------------|---------------|
|  | <b>LULU Wall elbow - Chrome</b> | 28 450 710-00 |
|---|---------------------------------|---------------|

**Required miscellaneous**

|   |  |                       |
|---|--|-----------------------|
|  | <b>Hand shower FlowReduce -<br/>Chrome</b> | 28 012 979-00<br>0010 |
|---|--|-----------------------|

**Required miscellaneous**

|   |                             |               |
|---|-----------------------------|---------------|
|  | <b>Hand shower - Chrome</b> | 28 016 979-00 |
|---|-----------------------------|---------------|

**Required miscellaneous**

|   |                             |               |
|---|-----------------------------|---------------|
|  | <b>Hand shower - Chrome</b> | 28 018 979-00 |
|---|-----------------------------|---------------|

ST 050 201 8710

mm [inches]

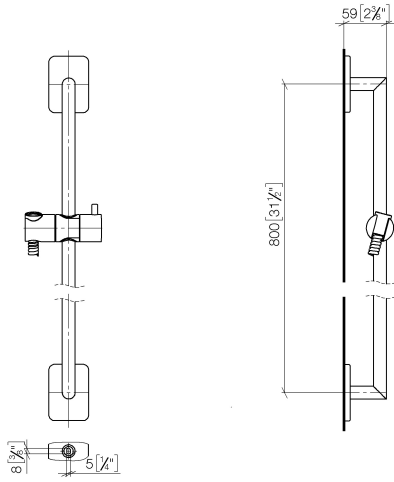

Certificates

WRAS\_2009048. ACS\_20 ACC LY 738. IAPMO\_4976 (2).

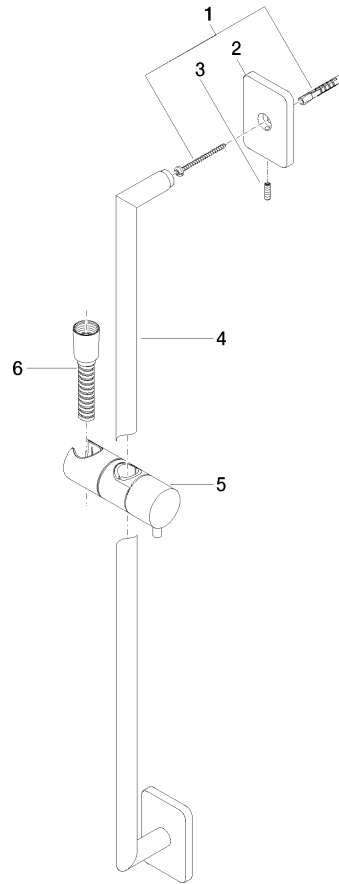

Spare parts list

| No. | Item Number        | Name   | Quantity used | Delivery time |
|-----|--------------------|--|---------------|---------------|
| 1   | 05 30 31 025 00 90 | fixing set                                       | 2             | 2             |
| 2   | 09 27 71 005-00    | rosette  | 2             | 10            |
| 3   | 09 31 11 013 90    | pin  | 2             | 2             |
| 4   | 05 28 22 590 01-00 | bar  | 1             | 10            |
| 5   | 12 580 970-00      | Slide unit - Chrome                              | 1             | 10            |
| 6   | 28 322 970-00      | Metal shower hose 1/2" x 3/8" x 1750 mm - Chrome | 1             | 2             |



























ST 050 201 8710



- Four settings: COMPACT RAIN, COMPACT SOFT FLOW, COMPACT AQUAPRESSURE FLOW, COMPACT CASCADE, max. flow rate 6.8 l/min (at 3 bar)
- with anti-scale system
- spray head Ø 120mm
- 1/2" connection
- This product can help a building meet the requirements of Green Building Rating Systems, e.g. LEED®, BREEAM®, DGNB

Intrinsic protection against back flow.

Fits: IMO, LULU, MADISON, MEM, TARA, CL.1, LISSÉ, VAIA, META, CYO

|  |                                |                    |
|--|--------------------------------|--------------------|
|    | Chrome                         | 28 012 979-00 0010 |
|    | Chrome                         | 28 012 979-00      |
|    | Brushed Platinum               | 28 012 979-06 0010 |
|    | Brushed Platinum               | 28 012 979-06      |
|    | Platinum                       | 28 012 979-08      |
|    | Platinum                       | 28 012 979-08 0010 |
|    | Dark Chrome                    | 28 012 979-19      |
|    | Dark Chrome                    | 28 012 979-19 0010 |
|    | Light Gold                     | 28 012 979-26      |
|    | Light Gold                     | 28 012 979-26 0010 |
|   | Brushed Light Gold             | 28 012 979-27      |
|  | Brushed Light Gold             | 28 012 979-27 0010 |
|  | Brushed Durabronze (23kt Gold) | 28 012 979-28      |
|  | Brushed Durabronze (23kt Gold) | 28 012 979-28 0010 |
|  | Matte Black                    | 28 012 979-33      |
|  | Matte Black                    | 28 012 979-33 0010 |
|  | Brushed Bronze                 | 28 012 979-42      |
|  | Brushed Bronze                 | 28 012 979-42 0010 |
|  | Brushed Champagne (22kt Gold)  | 28 012 979-46 0010 |
|  | Brushed Champagne (22kt Gold)  | 28 012 979-46      |
|  | Champagne (22kt Gold)          | 28 012 979-47      |
|  | Champagne (22kt Gold)          | 28 012 979-47 0010 |
|  | Brushed Chrome                 | 28 012 979-93      |
|  | Brushed Chrome                 | 28 012 979-93 0010 |
|  | Brushed Dark Platinum          | 28 012 979-99 0010 |
|  | Brushed Dark Platinum          | 28 012 979-99      |



## LULU Shower set - Chrome

---

LULU

ST 050 201 8710



## LULU Shower set - Chrome

LULU

ST 050 201 8710

---





## LULU Shower set - Chrome

---

LULU

ST 050 201 8710

ST 050 201 8710

mm [inches]

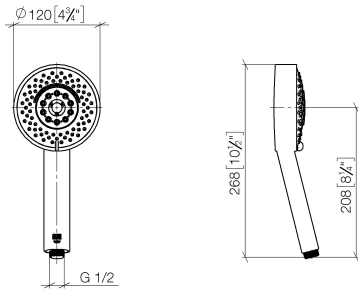

**Flow rate chart**

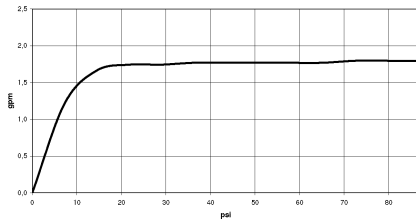

**Certificates**

LGA\_29980.

IAPMO\_4976 (4).

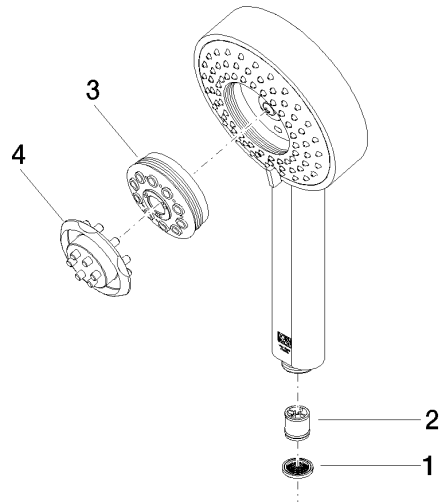

### Spare parts list

| No. | Item Number        | Name         | Quantity used | Delivery time |
|-----|--------------------|--------------|---------------|---------------|
| 1   | 09 23 01 039 90    | sieve        | 1             | 2             |
| 2   | 09 23 01 166 90    | flow reducer | 1             | 2             |
| 3   | 04 12 11 071 00 90 | shower       | 1             | 2             |
| 4   | 09 30 09 022 90    | key          | 1             | 2             |