

ST 050 203 2979



Fits: IMO, LISSÉ, META

- slide bar
- Pipe diameter 18 mm
- gauge 853 mm
- metal shower hose 1750mm with integrated anti-twist protection
- shower hose connector 3/8"
- Three or five settings: COMPACT RAIN, COMPACT SOFT FLOW, COMPACT AQUAPRESSURE FLOW, max. flow rate 6.8 l/min (at 3 bar)
- Function from: 6 l/min
- spray head Ø 100mm
- This product can help a building meet the requirements of Green Building Rating Systems, e.g. LEED®, BREEAM®, DGNB

	Matte Black	ST 050 203 2979-33 0010
	Chrome	ST 050 203 9979-00
	Chrome	ST 050 203 2979-00 0010
	Brushed Platinum	ST 050 203 9979-06
	Brushed Platinum	ST 050 203 2979-06 0010
	Platinum	ST 050 203 9979-08
	Platinum	ST 050 203 2979-08 0010
	Dark Chrome	ST 050 203 9979-19
	Dark Chrome	ST 050 203 2979-19 0010
	Light Gold	ST 050 203 2979-26 0010
	Light Gold	ST 050 203 9979-26
	Brushed Light Gold	ST 050 203 9979-27
	Brushed Light Gold	ST 050 203 2979-27 0010
	Brushed Durabronze (23kt Gold)	ST 050 203 9979-28
	Brushed Durabronze (23kt Gold)	ST 050 203 2979-28 0010
	Matte Black	ST 050 203 9979-33
	Brushed Bronze	ST 050 203 9979-42
	Brushed Bronze	ST 050 203 2979-42 0010
	Brushed Champagne (22kt Gold)	ST 050 203 9979-46
	Brushed Champagne (22kt Gold)	ST 050 203 2979-46 0010
	Champagne (22kt Gold)	ST 050 203 9979-47
	Champagne (22kt Gold)	ST 050 203 2979-47 0010
	Brushed Chrome	ST 050 203 9979-93
	Brushed Chrome	ST 050 203 2979-93 0010
	Brushed Dark Platinum	ST 050 203 9979-99
	Brushed Dark Platinum	ST 050 203 2979-99 0010

ST 050 203 2979

Individual components of this set

You need the following components for this set



1x 26 413 979-33



1x 28 018 979-33 0010



Shower set - Matte Black

IMO

ST 050 203 2979

ST 050 203 2979



Fits: IMO, LULU, MEM, TARA, CL.1, LISSÉ,
VAIA, META, CYO

- slide bar
- Pipe diameter 18 mm
- gauge 853 mm
- metal shower hose 1750mm with integrated anti-twist protection
- shower hose connector 3/8"

This article does not include a hand shower!

	Matte Black	26 413 979-33
	Chrome	26 413 979-00
	Brushed Platinum	26 413 979-06
	Platinum	26 413 979-08
	Dark Chrome	26 413 979-19
	Light Gold	26 413 979-26
	Brushed Light Gold	26 413 979-27
	Brushed Durabronze (23kt Gold)	26 413 979-28
	Brushed Bronze	26 413 979-42
	Brushed Champagne (22kt Gold)	26 413 979-46
	Champagne (22kt Gold)	26 413 979-47
	Brushed Chrome	26 413 979-93
	Brushed Dark Platinum	26 413 979-99

Recommended miscellaneous

	Concealed wall elbow - •max. recess depth 163 mm •min. recess depth 90 mm	35 085 970 90
---	--	---------------

Required miscellaneous

	Hand shower - Matte Black	28 016 979-33
---	----------------------------------	---------------

Required miscellaneous

	Hand shower FlowReduce - Matte Black	28 016 979-33 0010
---	---	-----------------------

Required miscellaneous

	Hand shower FlowReduce - Matte Black	28 012 979-33 0010
---	---	-----------------------

Required miscellaneous

	Hand shower FlowReduce - Matte Black	28 018 979-33 0010
---	---	-----------------------

Recommended miscellaneous

	Wall elbow - Matte Black	28 450 980-33
---	---------------------------------	---------------

Required miscellaneous

	Hand shower - Matte Black	28 012 979-33
---	----------------------------------	---------------

Required miscellaneous

	Hand shower - Matte Black	28 017 979-33
---	----------------------------------	---------------

Required miscellaneous

	Hand shower - Matte Black	28 018 979-33
---	----------------------------------	---------------

ST 050 203 2979

mm [inches]

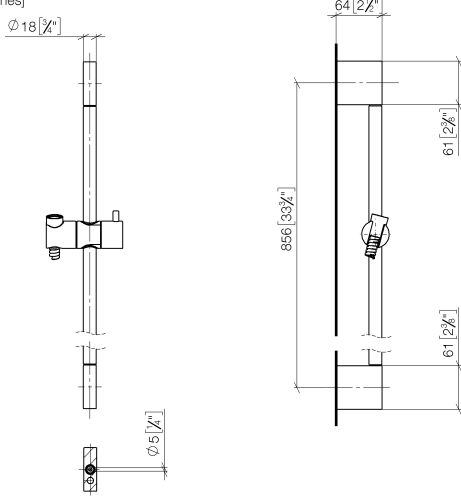

Certificates

WRAS_2009048. ACS_20 ACC LY 738. IAPMO_4976 (1).

ST 050 203 2979

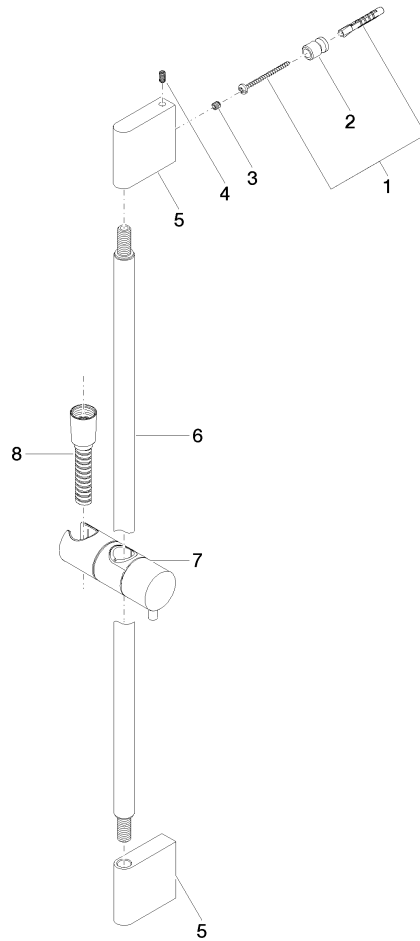

Spare parts list

No.	Item Number	Name	Quantity used	Delivery time
1	05 17 20 726 02 90	fixing set	2	2
2	08 17 20 726 90	holder	2	2
3	09 31 11 049 90	pin	2	2
4	04 31 11 113 00 90	pin	2	2
5	08 17 97 054-33	holder	2	30
6	90 28 22 597 00-33	holder	1	30
7	12 580 970-33	Slide unit - Matte Black	1	10
8	28 322 970-33	Metal shower hose 1/2" x 3/8" x 1750 mm - Matte Black	1	2





























ST 050 203 2979



Fits: IMO, LULU, MADISON, MEM, TARA, CL.1, LISSÉ, VAIA, META, CYO

- Three or five settings: COMPACT RAIN, COMPACT SOFT FLOW, COMPACT AQUAPRESSURE FLOW, max. flow rate 6.8 l/min (at 3 bar)
- with anti-scale system
- spray head Ø 100mm
- 1/2" connection
- Function from: 6 l/min
- This product can help a building meet the requirements of Green Building Rating Systems, e.g. LEED®, BREEAM®, DGNB

Intrinsic protection against back flow.

	Matte Black	28 018 979-33 0010
	Chrome	28 018 979-00
	Chrome	28 018 979-00 0010
	Brushed Platinum	28 018 979-06
	Brushed Platinum	28 018 979-06 0010
	Platinum	28 018 979-08
	Platinum	28 018 979-08 0010
	Dark Brass matt	28 018 979-16 0010
	Dark Bronze matt	28 018 979-17 0010
	Dark Chrome	28 018 979-19
	Dark Chrome	28 018 979-19 0010
	Light Gold	28 018 979-26 0010
	Light Gold	28 018 979-26
	Brushed Light Gold	28 018 979-27 0010
	Brushed Light Gold	28 018 979-27
	Brushed Durabrass (23kt Gold)	28 018 979-28
	Brushed Durabrass (23kt Gold)	28 018 979-28 0010
	Matte Black	28 018 979-33
	Brushed Bronze	28 018 979-42 0010
	Brushed Bronze	28 018 979-42
	Brushed Champagne (22kt Gold)	28 018 979-46
	Brushed Champagne (22kt Gold)	28 018 979-46 0010
	Champagne (22kt Gold)	28 018 979-47
	Champagne (22kt Gold)	28 018 979-47 0010
	Brushed Chrome	28 018 979-93
	Brushed Chrome	28 018 979-93 0010
	Brushed Dark Platinum	28 018 979-99
	Brushed Dark Platinum	28 018 979-99 0010



Shower set - Matte Black

IMO

ST 050 203 2979



Shower set - Matte Black

IMO

ST 050 203 2979

ST 050 203 2979

mm [inches]

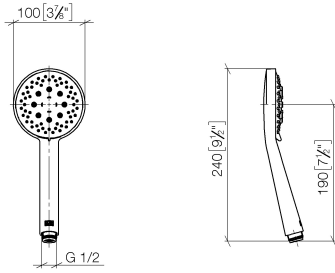

Flow rate chart

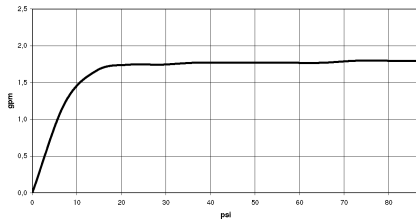

Certificates

LGA_29984.

Spare parts list

No.	Item Number	Name	Quantity used	Delivery time
1	09 23 01 039 90	sieve	1	2