

ST 050 303 4892



- shower with fixed riser projection 420mm
- Rain shower: PURE RAIN, max. flow rate 7 l/min (at 3 bar)
- rain shower Ø 220 mm
- rain shower with anti-scale system
- Hand shower: COMPACT RAIN, max. flow rate 15 l/min (at 3 bar)
- spray head Ø 100mm
- rotary diverter for fixed-riser shower/hand shower
- height of fittings up to rain shower (bottom edge) 1007mm
- height of fittings up to top edge of elbow 1167mm
- rosette for shower holder Ø 55mm
- rosette for wall mounting Ø 57mm
- rosette for shower mixer Ø 65mm
- gauge 150 mm - 13 mm
- 1500 mm metal shower hose
- 1/2" connection
- Pipe diameter 20 mm

	Brushed Dark Platinum	ST 050 303 4892-99
	Chrome	ST 050 303 4892-00
	Brushed Platinum	ST 050 303 4892-06
	Platinum	ST 050 303 4892-08
	Dark Chrome	ST 050 303 4892-19
	Brushed Light Gold	ST 050 303 4892-27
	Brushed Durabrass (23kt Gold)	ST 050 303 4892-28
	Matte Black	ST 050 303 4892-33
	Brushed Bronze	ST 050 303 4892-42
	Brushed Champagne (22kt Gold)	ST 050 303 4892-46
	Champagne (22kt Gold)	ST 050 303 4892-47
	Brushed Chrome	ST 050 303 4892-93

**Individual components of this set**

You need the following components for this set



1x 26 633 892-99



1x 28 018 979-99



## TARA Showerpipe 220 mm - Brushed Dark Platinum

---

TARA

ST 050 303 4892

ST 050 303 4892



- shower with fixed riser projection 420mm
- overhead shower: rain flow
- rain shower Ø 220 mm
- rain shower with anti-scale system
- max. rainshower flow 7 l/min
- rotary diverter for fixed-riser shower/hand shower
- height of fittings up to rain shower (bottom edge) 1007mm
- height of fittings up to top edge of elbow 1167mm
- rosette for shower holder Ø 55mm
- rosette for wall mounting Ø 57mm
- rosette for shower mixer Ø 65mm
- gauge 150 mm - 13 mm
- 1500 mm metal shower hose
- 1/2" connection
- Pipe diameter 20 mm
- quick clearing
- This product can help a building meet the requirements of Green Building Rating Systems, e.g. LEED®, BREEAM®, DGNB

This article does not include a hand shower!

Intrinsic protection against back flow.

	Brushed Dark Platinum	26 633 892-99
	Chrome	26 633 892-00
	Brushed Platinum	26 633 892-06
	Platinum	26 633 892-08
	Dark Chrome	26 633 892-19
	Brushed Durabronze (23kt Gold)	26 633 892-28
	Matte Black	26 633 892-33
	Brushed Champagne (22kt Gold)	26 633 892-46
	Champagne (22kt Gold)	26 633 892-47
	Brushed Chrome	26 633 892-93

Required miscellaneous

	<b>Hand shower - Brushed Dark Platinum</b>	28 015 979-99
--	--	---------------

Required miscellaneous

	<b>Hand shower - Brushed Dark Platinum</b>	28 017 979-99
--	--	---------------

Required miscellaneous

	<b>Hand shower - Brushed Dark Platinum</b>	28 012 979-99
--	--	---------------

Required miscellaneous

	<b>Hand shower - Brushed Dark Platinum</b>	28 018 979-99
--	--	---------------

Required miscellaneous

	<b>Hand shower FlowReduce - Brushed Dark Platinum</b>	28 012 979-99 0010
--	---	--------------------

Required miscellaneous

	<b>Hand shower - Brushed Dark Platinum</b>	28 016 979-99
--	--	---------------

Required miscellaneous

	<b>Hand shower FlowReduce - Brushed Dark Platinum</b>	28 016 979-99 0010
--	---	--------------------

Required miscellaneous

	<b>Hand shower FlowReduce - Brushed Dark Platinum</b>	28 018 979-99 0010
--	---	--------------------

Flow rate chart

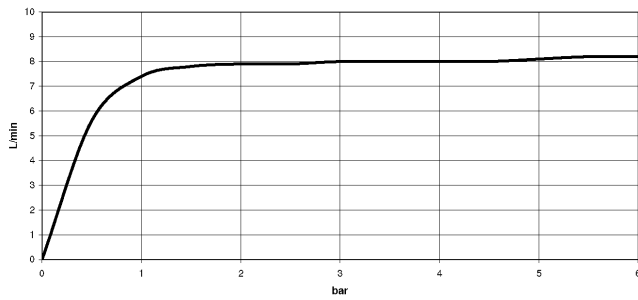

Certificates

Belgaqua\_21-023- WRAS\_2204012. LGA\_38735.  
27\_8.

ST 050 303 4892

Parts for other finishes can be found here: [Chrome](#)

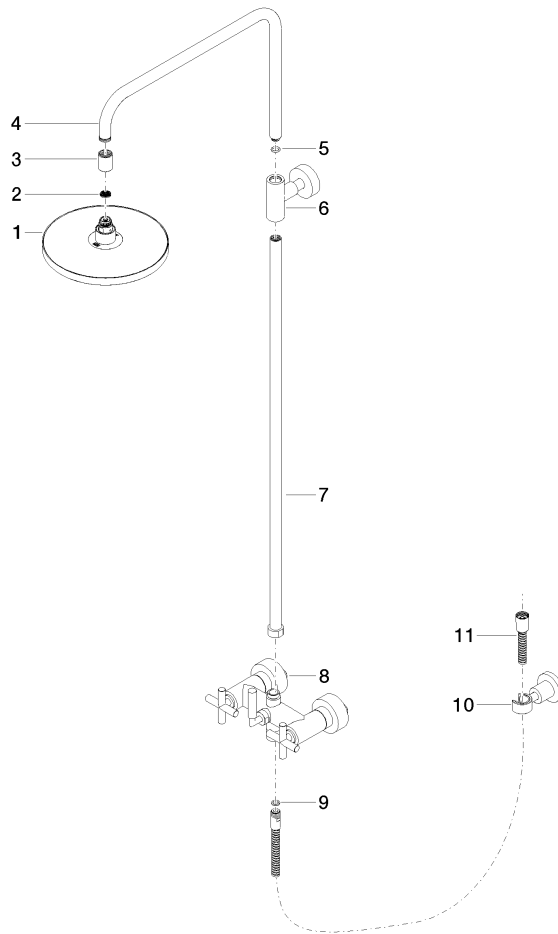

### Spare parts list

No.	Item Number	Name	Quantity used	Delivery time
1	90 12 05 092 20-99	shower	1	30
2	09 23 01 039 90	sieve	1	2
3	09 24 03 177 20-99	adaptor	1	30
4	04 28 22 101 20-99	spout	1	30
5	90 14 10 011 00 90	seal	1	2
6	90 17 11 037 00-99	holder	1	30
7	90 28 22 096 00-99	pipe	1	30
8	04 17 10 020 01-99	fitting	1	30
9	90 14 20 026 00 90	seal	1	2
10	28 050 892-99	TARA Wall bracket - Brushed Dark Platinum	1	30
11	28 304 970-99	Metal shower hose 1/2" x 3/8" x 1500 mm - Brushed Dark Platinum	1	30





























ST 050 303 4892



- Three or five settings: COMPACT RAIN, COMPACT SOFT FLOW, COMPACT AQUAPRESSURE FLOW, max. flow rate 15 l/min (at 3 bar)
- with anti-scale system
- spray head Ø 100mm
- 1/2" connection
- WRAS 1704043
- Function from: 7 l/min

Intrinsic protection against back flow.

Fits: IMO, LULU, MADISON, MEM, TARA, CL.1, LISSÉ, VAIA, META, CYO

	Brushed Dark Platinum	28 018 979-99
	Chrome	28 018 979-00
	Chrome	28 018 979-00 0010
	Brushed Platinum	28 018 979-06
	Brushed Platinum	28 018 979-06 0010
	Platinum	28 018 979-08
	Platinum	28 018 979-08 0010
	Dark Brass matt	28 018 979-16 0010
	Dark Bronze matt	28 018 979-17 0010
	Dark Chrome	28 018 979-19
	Dark Chrome	28 018 979-19 0010
	Light Gold	28 018 979-26 0010
	Light Gold	28 018 979-26
	Brushed Light Gold	28 018 979-27 0010
	Brushed Light Gold	28 018 979-27
	Brushed Durabrass (23kt Gold)	28 018 979-28
	Brushed Durabrass (23kt Gold)	28 018 979-28 0010
	Matte Black	28 018 979-33
	Matte Black	28 018 979-33 0010
	Brushed Bronze	28 018 979-42 0010
	Brushed Bronze	28 018 979-42
	Brushed Champagne (22kt Gold)	28 018 979-46
	Brushed Champagne (22kt Gold)	28 018 979-46 0010
	Champagne (22kt Gold)	28 018 979-47
	Champagne (22kt Gold)	28 018 979-47 0010
	Brushed Chrome	28 018 979-93
	Brushed Chrome	28 018 979-93 0010
	Brushed Dark Platinum	28 018 979-99 0010



## TARA Showerpipe 220 mm - Brushed Dark Platinum

---

TARA

ST 050 303 4892



## TARA Showerpipe 220 mm - Brushed Dark Platinum

---

TARA

ST 050 303 4892





## TARA Showerpipe 220 mm - Brushed Dark Platinum

---

TARA

ST 050 303 4892

ST 050 303 4892

mm [inches]

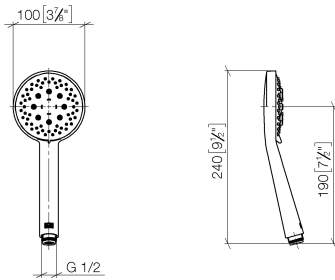

### Flow rate chart

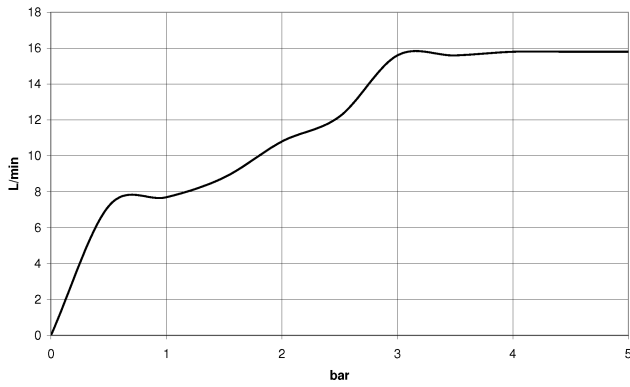

### Certificates

LGA\_29984.

DVGW\_DW-  
6517DN0129.

WRAS\_2210003.

ST 050 303 4892

Parts for other  
finishes can be found  
here: [Chrome](#)



### Spare parts list

No.	Item Number	Name	Quantity used	Delivery time
1	09 23 01 039 90	sieve	1	2