

ST 050 306 6979



Fits: IMO, LULU, TARA, LISSÉ, VAIA, META, CYO

- shower with fixed riser projection 453mm
- Rain shower: PURE RAIN, max. flow rate 14 l/min (at 3 bar)
- Function from: 10 l/min
- rain shower Ø 300 mm
- rain shower with anti-scale system
- Hand shower: Three or five settings: COMPACT RAIN, COMPACT SOFT FLOW, COMPACT AQUAPRESSURE FLOW, max. flow rate 15 l/min (at 3 bar)
- spray head Ø 100mm
- rotary diverter with volume control and shut-off function
- slide-on rosettes Ø 70 mm
- height of fittings up to rain shower (bottom edge) 1009mm
- height of fittings up to top edge of elbow 1150mm
- gauge 150 mm - 13 mm
- metal shower hose 1750mm with integrated anti-twist protection
- 1/2" connection
- slide bar
- Pipe diameter 23.5 mm

	Brushed Dark Platinum	ST 050 306 6979-99
	Chrome	ST 050 306 6979-00
	Brushed Platinum	ST 050 306 6979-06
	Platinum	ST 050 306 6979-08
	Dark Chrome	ST 050 306 6979-19
	Light Gold	ST 050 306 6979-26
	Brushed Light Gold	ST 050 306 6979-27
	Brushed Durabrass (23kt Gold)	ST 050 306 6979-28
	Matte Black	ST 050 306 6979-33
	Brushed Bronze	ST 050 306 6979-42
	Brushed Champagne (22kt Gold)	ST 050 306 6979-46
	Champagne (22kt Gold)	ST 050 306 6979-47
	Brushed Chrome	ST 050 306 6979-93

Individual components of this set

You need the following components for this set



1x 34 460 979-99



1x 28 018 979-99



Showerpipe with shower thermostat - Brushed Dark Platinum

IMO

ST 050 306 6979

ST 050 306 6979



Fits: IMO, LULU, TARA, LISSÉ, VAIA, META

- shower with fixed riser projection 453mm
- overhead shower: rain flow
- rain shower Ø 300 mm
- rain shower with anti-scale system
- max. rainshower flow 14 l/min
- Function from: 10 l/min
- rotary diverter with volume control and shut-off function
- slide-on rosettes Ø 70 mm
- height of fittings up to rain shower (bottom edge) 1009mm
- height of fittings up to top edge of elbow 1150mm
- gauge 150 mm - 13 mm
- metal shower hose 1750mm with integrated anti-twist protection
- 1/2" connection
- slide bar
- Pipe diameter 23.5 mm
- quick clearing

This article does not include a hand shower!

Intrinsic protection against back flow.

	Brushed Dark Platinum	34 460 979-99
	Chrome	34 460 979-00
	Brushed Platinum	34 460 979-06
	Platinum	34 460 979-08
	Dark Chrome	34 460 979-19
	Dark Chrome	34 460 979-19 0010
	Light Gold	34 460 979-26
	Brushed Light Gold	34 460 979-27
	Brushed Durabronze (23kt Gold)	34 460 979-28
	Matte Black	34 460 979-33
	Brushed Bronze	34 460 979-42
	Brushed Champagne (22kt Gold)	34 460 979-46
	Champagne (22kt Gold)	34 460 979-47
	Brushed Chrome	34 460 979-93

Required miscellaneous

	Hand shower FlowReduce - Brushed Dark Platinum	28 012 979-99 0010
--	---	-----------------------

Required miscellaneous

	Hand shower - Brushed Dark Platinum	28 016 979-99
--	--	---------------

Required miscellaneous

	Hand shower FlowReduce - Brushed Dark Platinum	28 016 979-99 0010
--	---	-----------------------

Required miscellaneous

	Hand shower FlowReduce - Brushed Dark Platinum	28 018 979-99 0010
--	---	-----------------------

Required miscellaneous

	Hand shower - Brushed Dark Platinum	28 017 979-99
--	--	---------------

Required miscellaneous

	Hand shower - Brushed Dark Platinum	28 012 979-99
--	--	---------------

Required miscellaneous

	Hand shower - Brushed Dark Platinum	28 018 979-99
--	--	---------------

ST 050 306 6979

mm [inches]
1:10

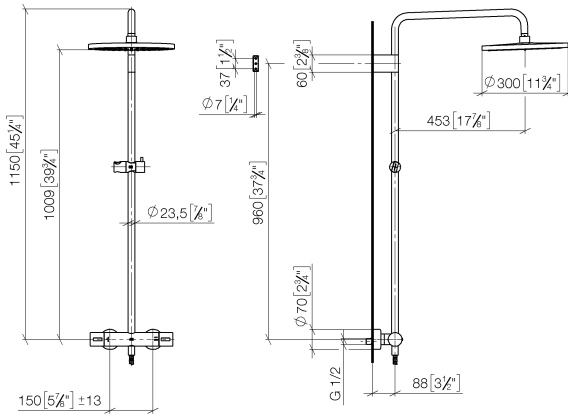

Flow rate chart

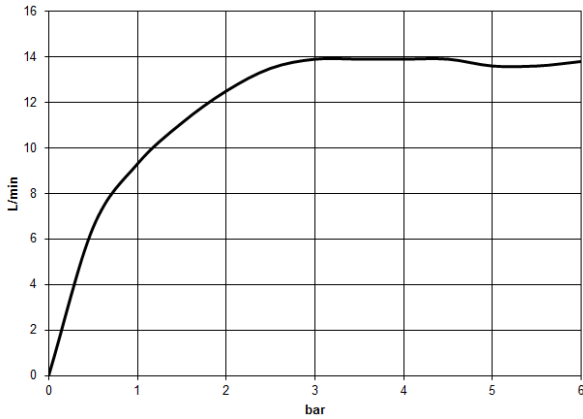

Certificates

DVGW_DW-6509DN0123. Belgaqua_21-032-27_5. WRAS_2204013. LGA_38736.

ST 050 306 6979

Parts for other finishes can be found here: [Chrome](#)

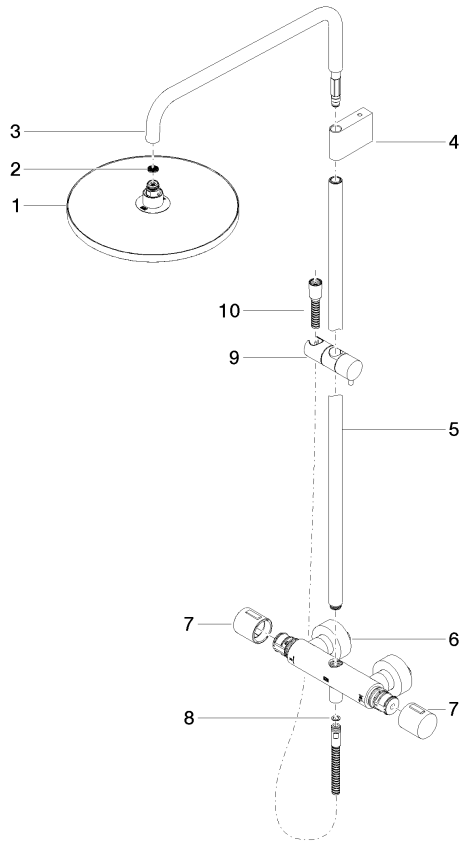

Spare parts list

No.	Item Number	Name	Quantity used	Delivery time
1	04 12 05 091 00-99	shower	1	30
2	09 23 01 039 90	sieve	1	2
3	90 28 22 348 00-99	pipe	1	30
4	90 17 11 150 00-99	holder	1	30
5	90 28 22 349 00-99	pipe	1	30
6	04 17 01 250 00-99	connection	1	30
7	90 17 33 015 00-99	handle	2	30
8	90 14 20 026 00 90	seal	1	2
9	12 570 970-99	Slide unit - Brushed Dark Platinum	1	30
10	28 322 970-99	Metal shower hose 1/2" x 3/8" x 1750 mm - Brushed Dark Platinum	1	2

Showerpipe with shower thermostat - Brushed Dark Platinum

IMO





























ST 050 306 6979



- Three or five settings: COMPACT RAIN, COMPACT SOFT FLOW, COMPACT AQUAPRESSURE FLOW, max. flow rate 15 l/min (at 3 bar)
- with anti-scale system
- spray head Ø 100mm
- 1/2" connection
- WRAS 1704043
- Function from: 7 l/min

Intrinsic protection against back flow.

Fits: IMO, LULU, MADISON, MEM, TARA, CL.1, LISSÉ, VAIA, META, CYO

	Brushed Dark Platinum	28 018 979-99
	Chrome	28 018 979-00
	Chrome	28 018 979-00 0010
	Brushed Platinum	28 018 979-06
	Brushed Platinum	28 018 979-06 0010
	Platinum	28 018 979-08
	Platinum	28 018 979-08 0010
	Dark Brass matt	28 018 979-16 0010
	Dark Bronze matt	28 018 979-17 0010
	Dark Chrome	28 018 979-19
	Dark Chrome	28 018 979-19 0010
	Light Gold	28 018 979-26 0010
	Light Gold	28 018 979-26
	Brushed Light Gold	28 018 979-27 0010
	Brushed Light Gold	28 018 979-27
	Brushed Durabrass (23kt Gold)	28 018 979-28
	Brushed Durabrass (23kt Gold)	28 018 979-28 0010
	Matte Black	28 018 979-33
	Matte Black	28 018 979-33 0010
	Brushed Bronze	28 018 979-42 0010
	Brushed Bronze	28 018 979-42
	Brushed Champagne (22kt Gold)	28 018 979-46
	Brushed Champagne (22kt Gold)	28 018 979-46 0010
	Champagne (22kt Gold)	28 018 979-47
	Champagne (22kt Gold)	28 018 979-47 0010
	Brushed Chrome	28 018 979-93
	Brushed Chrome	28 018 979-93 0010
	Brushed Dark Platinum	28 018 979-99 0010



Showerpipe with shower thermostat - Brushed Dark Platinum

IMO

ST 050 306 6979



Showerpipe with shower thermostat - Brushed Dark Platinum

IMO

ST 050 306 6979



Showerpipe with shower thermostat - Brushed Dark Platinum

IMO

ST 050 306 6979

ST 050 306 6979

mm [inches]



Flow rate chart



Certificates

LGA_29984.

DVGW_DW-
6517DN0129.

WRAS_2210003.

ST 050 306 6979

Parts for other
finishes can be found
here: [Chrome](#)



Spare parts list

No.	Item Number	Name	Quantity used	Delivery time
1	09 23 01 039 90	sieve	1	2