







28 060 970

• girevole 75°



Compatibile con: IMO, LULU, MADISON,
MEM, TARA, CL.1, LISSÉ, VAIA, META,
CYO

	Ottone spazzolato (Oro 23k)	28 060 970-28
	Cromato	28 060 970-00
	Platinato spazzolato	28 060 970-06
	Platinato	28 060 970-08
	Dark Brass matt	28 060 970-16
	Dark Chrome	28 060 970-19
	Light Gold	28 060 970-26
	Light Gold spazzolato	28 060 970-27
	Nero opaco	28 060 970-33
	Bronzo spazzolato	28 060 970-42
	Champagne spazzolato (Oro 22k)	28 060 970-46
	Champagne (Oro 22k)	28 060 970-47
	Cromo spazzolato	28 060 970-93
	Dark Platinum spazzolato	28 060 970-99

28 060 970

mm [inches]

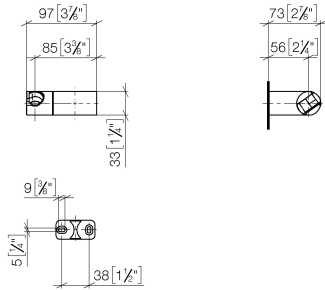

28 060 970

Parts for other
finishes can be found
here: Cromato

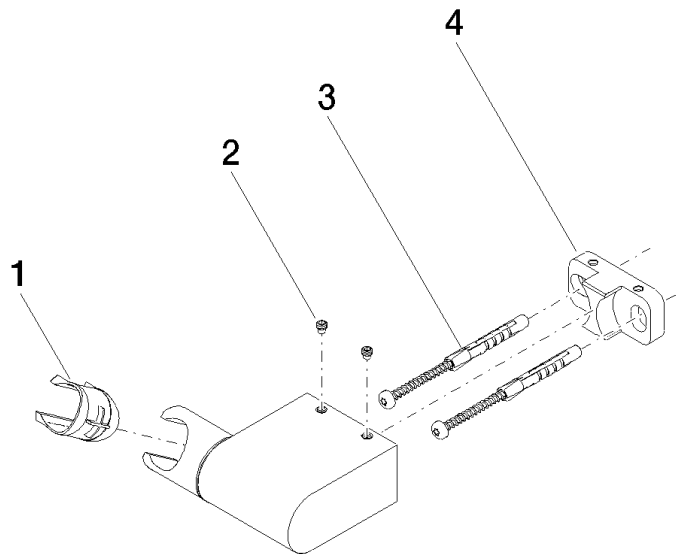

Elenco delle parti di ricambio

N.	Codice articolo	Denominazione	Quantità necessaria	Tempo di produzione
1	09 12 12 212 90	bussola	1	2
2	09 31 11 009 90	perno	2	2
3	05 30 31 025 00 90	set di fissaggio	1	2
4	08 30 11 563 90	sostegno	1	2