









28 678 670



- sporgenza 450 mm
- Soffione a pioggia Ø 300 mm
- Getto a pioggia
- portata max 9 l/min
- Funzione a partire da: 7 l/min
- rosetta 65 x 65 mm
- ingresso 1/2"
- con sistema anticalcare
- con funzione neutra
- Questo prodotto può aiutare un edificio a soddisfare i requisiti dei Green Building Rating Systems, ad es. LEED®, BREEAM®, DGNB

	Dark Chrome	28 678 670-19
	Cromato	28 678 670-00
	cromato spazzolato	28 678 670-93
	Platinato spazzolato	28 678 670-06
	Platinato	28 678 670-08
	Light Gold spazzolato	28 678 670-27
	Ottone spazzolato (Oro 23k)	28 678 670-28
	Nero opaco	28 678 670-33
	Champagne spazzolato (Oro 22k)	28 678 670-46
	Champagne (Oro 22k)	28 678 670-47
	Dark Platinum spazzolato	28 678 670-99

28 678 670

mm [inches]



Diagramma di portata



Certificati

LGA\_29235.

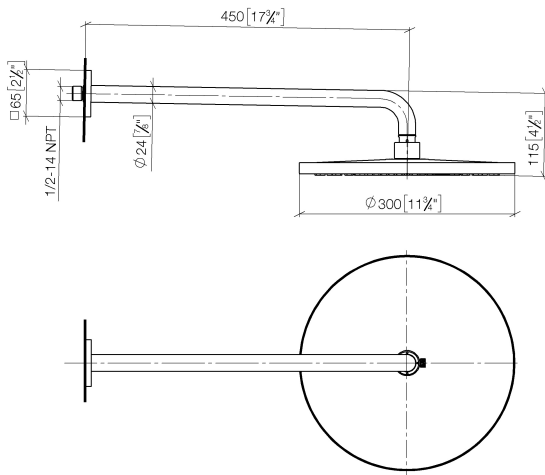
28 678 670

Elenco delle parti di ricambio

N.	Codice articolo	Denominazione	Quantità necessaria	Tempo di produzione
1	04 30 31 032 00 90	set di fissaggio	1	2
2	09 17 20 120 90	sostegno	1	2
3	09 14 10 150 90	guarnizione	2	2
4	09 27 67 015-19	rosetta	1	60
5	90 11 03 070 00-19	tubo	1	20
6	09 23 01 075 90	inserto	1	2
7	90 12 05 091 20-19	doccia	1	20
8	90 30 09 069 00 90	chiave	1	2