







33 521 845



- sporgenza 130 mm
- bocca fissa
- Getto circolare con aria
- altezza rubinetteria 127 mm
- altezza fino al rompigitto 75 mm
- diametro foro 35 mm
- 2x tubo flessibile di mandata M 8 x 1 avvitato, tenuta controllata
- portata max 5,7 l/min
- senza piombo
- Questo prodotto può aiutare un edificio a soddisfare i requisiti dei Green Building Rating Systems, ad es. LEED®, BREEAM®, DGNB

	Dark Chrome	33 521 845-19
	Cromato	33 521 845-00
	Platinato spazzolato	33 521 845-06
	Nero opaco	33 521 845-33
	Cromo spazzolato	33 521 845-93
	Dark Platinum spazzolato	33 521 845-99

33 521 845



Diagramma di portata



Certificati

LGA_29008.

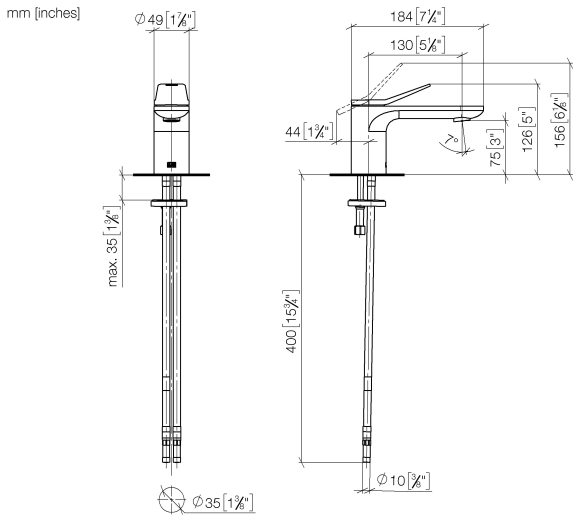
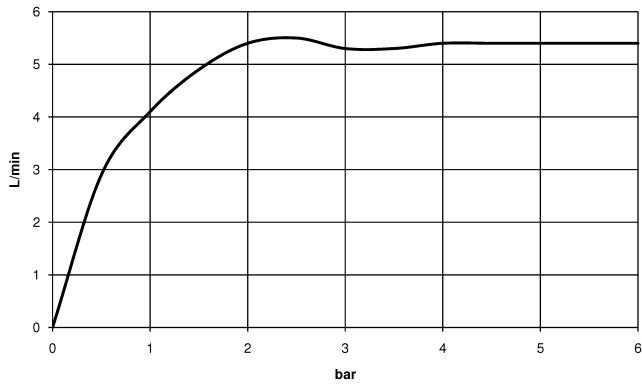
GDV_0400310.

33 521 845

Parts for other
finishes can be found
here: [Cromato](#)

